



ET6000, ET6010, ET6500 ExacTime GPS Time Code And Frequency Generator

Covering Configurations:
ET6000, ET6010, ET6500-TCXO
ET6000, ET6010, ET6500-OCXO
ET6000, ET6010, ET6500-RB1

Revision C
User's Guide

8500-0105

June, 2005

**ET6000, ET6010, and ET6500
EXACTIME GPS TIME CODE AND FREQUENCY GENERATOR**

TABLE OF CONTENTS

SECTION	PAGE
CHAPTER ONE GENERAL INFORMATION	
1.0 INTRODUCTION	1-1
1.1 USER'S GUIDE SUMMARY	1-1
1.2 NAVSTAR/GPS DESCRIPTION	1-2
1.3 PRODUCT DESCRIPTION	1-3
1.4 SPECIFICATIONS.....	1-4
1.4.1 GPS SUBSYSTEM.....	1-4
1.4.2 TIMING OUTPUTS	1-4
1.4.3 ACCURACY	1-7
1.4.4 TIMING INPUTS	1-7
1.4.5 J12 RS-232 I/O INTERFACE	1-8
1.4.6 INTERNAL TIME BASE.....	1-8
1.4.7 PRIMARY POWER	1-11
1.4.8 DIMENSIONS	1-13
1.4.9 WEIGHT.....	1-13
1.4.10 ENVIRONMENT	1-13
1.5 ADDITIONAL SPECIFICATIONS	1-14
1.5.1 ANTENNA/PREAMP	1-14
1.5.2 GPS RPU AND ANTENNA.....	1-14
1.6 FUNCTIONAL CHARACTERISTICS.....	1-14
1.6.1 ACQUISITION.....	1-14
1.6.2 SIGNAL INTERRUPTION.....	1-15
1.6.3 POSITION AND VELOCITY SOLUTION.....	1-15
1.6.4 DYNAMIC CAPABILITY.....	1-16
1.6.5 RF JAMMING RESISTANCE AND BURN-OUT PROTECTION.....	1-16
1.6.6 SYSTEM STATUS AND DIAGNOSTICS	1-16
1.6.7 GPS SOLUTION MODES	1-16
1.6.8 ELEVATION ANGLE MASK.....	1-17

TABLE OF CONTENTS

**CHAPTER TWO
INSTALLATION**

2.0 INTRODUCTION 2-1

2.1 UNPACKING AND INSPECTION 2-1

2.2 RACK MOUNTING PROCEDURE 2-1

 2.2.1 TMRA 2-1

 2.2.2 ELEVATED AMBIENT OPERATING TEMPERATURE 2-1

 2.2.3 REDUCED AIR FLOW 2-2

 2.2.4 MECHANICAL LOADING 2-2

 2.2.5 CIRCUIT OVERLOADING 2-2

 2.2.6 RELIABLE EARTHING 2-2

2.3 ANTENNA/PREAMP INSTALLATION 2-2

2.4 ANTENNA/PREAMP INTERFACE CONNECTIONS 2-2

2.5 PRIMARY POWER CONNECTION 2-3

2.6 GPS TIMING UNIT INTERFACE CONNECTIONS 2-6

 2.6.1 RS-232 I/O INTERFACE J12 2-6

 2.6.2 PRINTER OUTPUT PORT J11 2-7

 2.6.3 TIMING OUTPUTS 2-7

 2.6.4 1PPS INPUT 2-8

 2.6.5 OSCILLATOR CONFIGURATION 2-8

**CHAPTER THREE
OPERATION**

3.0 INTRODUCTION 3-1

3.1 OPERATIONAL STEPS 3-1

 3.1.1 INITIALIZATION (UNKNOWN POSITION) 3-1

 3.1.2 INITIALIZATION (KNOWN POSITION) 3-3

3.2 OPERATIONAL CHARACTERISTICS 3-4

3.3 LIQUID CRYSTAL DISPLAY 3-4

 3.3.1 MAIN MENU SCREEN 3-4

 3.3.2 POSITION MENU SCREEN 3-9

 3.3.3 SET-UP MENU SCREEN 3-10

 3.3.4 RS232 I/O CONFIGURATION MENU SCREEN 3-15

 3.3.5 MULTIPLE TIME CODE OUTPUTS MENU SCREEN 3-16

 3.3.6 PRESET COINCIDENCE MENU SCREEN 3-16

 3.3.7 EXTERNAL FREQUENCY MEASUREMENT MENU SCREEN 3-17

 3.3.8 SINGLE EVENT LOG MENU SCREEN 3-18

 3.3.9 50/60HZ MEASUREMENT SCREEN 3-19

 3.3.10 AUTO DAYLIGHT SAVINGS MENU SCREEN 3-20

 3.3.11 MUX OUTPUT MENU SCREEN 3-21

3.3.12 PRINTER PORT CONFIGURATION MENU SCREEN..... 3-23
 3.3.13 IEEE-488 I/O INTERFACE MENU SCREEN 3-26
 3.4 CONFIGURATION OF REAR PANEL BNC CONNECTORS J4-J9..... 3-26

**CHAPTER FOUR
 I/O PORT DATA INPUT/OUTPUT**

4.0 INTRODUCTION 4-1
 4.1 SYMMETRICOM FIRMWARE VERSION..... 4-3
 4.2 UTC SYNC..... 4-4
 4.3 GPS SYNC..... 4-4
 4.4 PRINT FREQUENCY OFFSET..... 4-4
 4.5 PRINT TIME, STATUS, ERROR CODE, AND SATELLITE VEHICLE NUMBERS 4-4
 4.6 PRINT POSITION..... 4-6
 4.7 CLEAR EVENT DATA 4-7
 4.8 PRINT EVENT DATA..... 4-7
 4.9 REQUEST ONE EVENT LOG DATA 4-8
 4.10 ENABLE SINGLE EVENT LOG 4-9
 4.11 DISABLE SINGLE EVENT LOG 4-9
 4.12 SELECT MODE 4-9
 4.13 ENABLE TIME INTERVAL 4-10
 4.14 DISABLE TIME INTERVAL 4-10
 4.15 REQUEST TIME INTERVAL..... 4-10
 4.16 REQUEST ELEVATION MASK ANGLE..... 4-11
 4.17 ENTER ELEVATION MASK ANGLE..... 4-11
 4.18 ENABLE DISCIPLINING 4-11
 4.19 DISABLE DISCIPLINING 4-11
 4.20 ENTER POSITION 4-12
 4.21 ENTER DAC VALUE..... 4-12
 4.22 REQUEST DAC VALUE..... 4-13
 4.23 NUMBER OF POSITION AVERAGES 4-13
 4.24 ENTER LOCAL OFFSET..... 4-13
 4.25 ENTER CABLE DELAY 4-14
 4.26 REQUEST CABLE DELAY 4-14
 4.27 RESYNCHRONIZE MINOR TIME 4-14
 4.28 SELECT DEFAULT VALUES 4-15
 4.29 EXTERNAL FREQUENCY MEASUREMENT – SELECT INPUT FREQUENCY 4-15
 4.30 EXTERNAL FREQUENCY MEASUREMENT – ENABLE/DISABLE 4-16
 4.31 EXTERNAL FREQUENCY MEASUREMENT – REQUEST DATA 4-16
 4.32 REQUEST SATELLITE SIGNAL SNR..... 4-16
 4.33 REQUEST UNIT OPERATING PARAMETERS 4-17
 4.34 ENABLE 50/60HZ MEASUREMENT 4-18

TABLE OF CONTENTS

4.35	50/60HZ SELECTION	4-18
4.36	ENTER 50/60HZ OFFSET DATA.....	4-18
4.37	REQUEST 50/60HZ MEASUREMENT DATA.....	4-19
4.38	PRINTER – SET-UP CONFIGURATION.....	4-19
4.39	PRINTER – REQUEST CONFIGURATION	4-20
4.40	PRINTER PORT MODE SELECTION	4-20
4.41	PRINTER – SELECT OUTPUT RATE	4-21
4.42	PRINTER – REQUEST OUTPUT RATE.....	4-21
4.43	ENABLE/DISABLE & DATA SELECT	4-21
4.44	ENTER PRESET COINCIDENCE TIME	4-23
4.45	REQUEST MUX OUTPUT	4-24
4.46	SET MUX OUTPUT	4-25
4.47	SET MAJOR TIME – TOD (TIME OF DAY).....	4-25
4.48	SET YEAR.....	4-25
4.49	AUTOMATIC DAYLIGHT SAVINGS TIME.....	4-26
4.49.1	DISABLE AUTO DAYLIGHT SAVINGS TIME FUNCTION.....	4-26
4.49.2	ENABLE AUTO DAYLIGHT SAVINGS TIME FUNCTION.....	4-26
4.49.3	SET AUTO DAYLIGHT SAVINGS TIME DEFAULT INTERVAL	4-26
4.49.4	REQUEST AUTO DAYLIGHT SAVINGS TIME INTERVAL.....	4-27
4.49.5	SET AUTO DAYLIGHT SAVINGS TIME INTERVAL.....	4-27
4.50	REQUEST UNIT SERIAL NUMBER.....	4-28

CHAPTER FIVE MAINTENANCE/TROUBLESHOOTING

5.0	MAINTENANCE	5-1
5.1	ADJUSTMENTS	5-1
5.1.1	INTERNAL OSCILLATOR CALIBRATION.....	5-1
5.1.2	LCD ADJUSTMENT	5-3
5.1.3	AC CODE ADJUSTMENTS.....	5-3
5.1.4	10MHZ SINE WAVE.....	5-3
5.1.5	10MHZ SQUARE WAVE.....	5-3
5.2	TROUBLESHOOTING.....	5-4
5.2.1	GENERAL.....	5-4
5.2.2	POWER LED WILL NOT ILLUMINATE WHEN ON/OFF SWITCH IS ACTIVATED	5-4
5.2.3	TRACKING LED DOES NOT ILLUMINATE.....	5-4
5.2.4	LOCKED LED DOES NOT ILLUMINATE	5-5
5.2.5	UNIT DOES NOT TRACK SATELLITES, ERROR MESSAGE/CODE – ANTENNA UNDERCURRENT	5-5
5.2.6	COLD RESET	5-5
5.3	THEORY OF OPERATION.....	5-6
5.3.1	GPS SYSTEM OPERATION.....	5-6

TABLE OF CONTENTS

5.3.2 MODES OF OPERATION..... 5-6
5.3.3 EXACTIME INTERNAL CONFIGURATION 5-8
5.3.4 MICROCOMPUTER PROGRAM THEORY OF OPERATION 5-9

**APPENDIX A
ASCII CHARACTER CODE TABLE**

PART ONE A-1
PART TWO A-2
PART THREE A-3
PART FOUR..... A-4

**APPENDIX B
GLOSSARY OF TERMS**

A..... B-1
B..... B-2
C..... B-2
D..... B-3
E..... B-3
F..... B-4
G..... B-4
H..... B-5
I..... B-5
J..... B-6
K..... B-6
L..... B-6
M..... B-7
N..... B-7
O..... B-8
P..... B-8
Q..... B-9
R..... B-9
S..... B-9
T..... B-10
U..... B-10
V..... B-10
W..... B-11
X..... B-11
Y..... B-11
Z..... B-11

TABLE OF CONTENTS

**APPENDIX C
OPTION DESCRIPTIONS**

GPS Opt 01/01A	Three Channel Encoder	C-1
GPS Opt 06A	1 MHz Sine Wave Shaper.....	C-16
GPS Opt 07A	5 MHz Sine Wave Shaper.....	C-17
GPS Opt 08CE	10-37VDC Dual Power Input	C-18
GPS Opt 08G	38-73VDC Power Supply	C-21
GPS Opt 08GP	38-73VDC Power Supply	C-23
GPS Opt 10B	Low Phase Noise Oscillator.....	C-28
GPS Opt 13A	Parallel BCD Output (Days – Milliseconds)	C-31
GPS Opt 14	IEEE-488 I/O Interface	C-36
GPS Opt 15A/15P	Rubidium Time Base 10MHz Oscillator (LPRO)	C-42
GPS Opt 15C	Rubidium Time Base 10MHz Oscillator (X72).....	C-45
GPS Opt 21A	10MHz Sine Wave Shaper.....	C-47
GPS Opt 23A/23B	Lightning Arrestor (w/25 or 50 ft. Antenna Cable	C-48
GPS Opt 27A,B,C,D	Signal Distribution.....	C-53
GPS Opt 33A	1.544/2.048MHz Square Wave Output.....	C-56
GPS Opt 33B/33C	T1/E1 Framed Ones – Balanced Output	C-57
GPS Opt 33D/33E	T1/E1 Framed Ones – Balanced Output w/Frame Marker etc.	C-65
GPS Opt 40/40P	GPS Option Motherboard (w/6 BNC outputs)	C-73
GPS Opt 40A/40AP	GPS Option Motherboard (w/1 BNC output).....	C-75
GPS Opt 40B/40BP	GPS Option Motherboard (w/3 BNC outputs)	C-77
GPS Opt 48	Pulse Rate Module	C-79

**APPENDIX D
ANTENNA REPLACEMENT KIT**

D.0	Antenna Replacement Kit.....	D-1
-----	------------------------------	-----

CHAPTER ONE

GENERAL INFORMATION

1.0 INTRODUCTION

This User's Guide describes the installation and operation of the ExacTime ET6xxx Global Positioning System (GPS) Time Code and Frequency Generator (TC&FG). Excluding options and size, the only difference between the different configurations is the oscillator.

The following are the available configurations and their respective oscillators:

ET6000-TCXO 10MHz Voltage Controlled Temperature Compensated Crystal Oscillator.

ET6010-TCXO

ET6500-TCXO

ET6000-OCXO 10MHz Voltage Controlled Ovenized Crystal Oscillator.

ET6010-OCXO

ET6500-OCXO

ET6000-RB1 10MHz Rubidium Oscillator with an aging rate of 5E-11 per month.

ET6010-RB1

ET6500-RB1

1.1 USER'S GUIDE SUMMARY

This User's Guide is divided into the following chapters:

A. CHAPTER ONE - GENERAL INFORMATION

This chapter includes a general description of the GPS Timing Unit and provides technical specifications.

B. CHAPTER TWO - INSTALLATION

Describes initial inspection, preparation for use, interconnections to antenna/preamp, power connections, and signal interconnections.

C. CHAPTER THREE - OPERATION

Describes the local operation of the unit.

D. CHAPTER FOUR - I/O PORT DATA INPUT/OUTPUT

Provides information on the protocol and data available through the RS-232C I/O port.

CHAPTER ONE

- E. CHAPTER FIVE - MAINTENANCE/TROUBLESHOOTING**
Provides a guide to the maintenance and troubleshooting of this instrument. A description of the available adjustments is also provided.
- F. APPENDIX A - ASCII CHARACTER CODES**
Provides the cross reference of the ASCII character set to decimal, octal, and hexadecimal numbers.
- G. APPENDIX B - ACRONYMS AND ABBREVIATIONS**
Provides a list of acronyms and abbreviations used in this User's Guide.
- H. APPENDIX C -OPTION DESCRIPTIONS**
The Option Descriptions that are available with this instrument are located in this Appendix.
- I. APPENDIX D –ANTENNA REPLACEMENT KIT**
Provides superseded model information.

1.2 NAVSTAR/GPS DESCRIPTION

The Navstar/GPS satellite-based timing and navigation system consists of a constellation of high altitude satellites orbiting the earth every twelve sidereal hours, a group of ground-based control/monitoring stations and the user equipment which may be located on land, sea and/or air.

The GPS System was completed in the early 1990's and provides three dimensional positioning, velocity, and time, on a continuous world-wide basis. The constellation is comprised of twenty-one satellites and three spares. The satellites are located in six different orbital planes inclined approximately sixty degrees to the equator at altitudes of 10,400 miles above the earth.

The GPS Timing Unit determines time and frequency by measuring the time of arrival of the precise timing mark and measuring the Doppler effect from one satellite. A previously entered or determined position allows computation of the receivers time offset. An accurate timing mark (1pps) can be set, and an input 1pps pulse can be measured with respect to UTC. The satellite positions are known within a few meters and the satellite clocks are calibrated within a few nanoseconds so position can be computed within an absolute accuracy of better than 120 meters (with current selective availability).

The GPS signal transmitted from a satellite consists of two carrier frequencies. L1 at a frequency of 1575.42 MHz and L2 at a frequency of 1227.6 MHz. The L1 signal is modulated with both a precision (P) code and a coarse acquisition (C/A) code. The precision (P) code is available to authorized users only. The GPS Timing Unit operates on the C/A code.

Each satellite transmits a unique C/A code that reflects the satellite identity for acquisition and tracking. The C/A PRN code is a gold code of 1023 bits repeating at a one-millisecond rate.

The L1 and L2 frequency is also modulated with a fifty-bit-per-second data stream providing satellite ephemerides, system time, satellite clock behavior, and status information on all satellites. The data message is contained in a data frame that is 1,500 bits long.

Ground based control/monitoring stations track the satellites and provide an upload several times each day to provide a prediction of each satellites ephemeris and clock behavior for the next day's operation.

1.3 PRODUCT DESCRIPTION

The GPS Timing Unit operates on the civilian L-band (1575.42MHz) utilizing C/A (Coarse Acquisition) code transmissions to monitor time and frequency data from the Navstar satellite constellation. Time and frequency is determined from satellite transmissions and calculations referenced to USNO (United States Naval Observatory) through the GPS Master Clock system. This link provides traceability to USNO and all international time scales through the use of publications from NIST (National Institute of Standards Technology), USNO, and BIPM (Bureau of International Des Poids et Measurements) in Servres, France.

The unit automatically acquires and tracks satellites based on health status and elevation angle. In the Stationary mode, time and frequency monitoring requires only one satellite, once accurate position data has been acquired or entered, although the receiver will use as many satellites as available. In "AUTO" mode, and the "Dynamic" mode, a minimum of four satellites are required for the GPS Timing unit to do three dimensional (latitude, longitude, and altitude) position fixes.

The basic GPS Timing Unit configuration includes the GPS Main Module, an antenna/preamp and a coaxial cable for interconnection. A corrected 1pps output signal and a 10MHz Sine Wave are provided. An RS-232 I/O Port is also provided in the basic configuration which can be used to control the unit as well to get data from the unit. The basic unit has an LCD Display and a keyboard. It generates IRIG B Serial Time Code, and has the capability of measuring the time interval difference between the GPS 1pps and an externally input 1pps (or it can measure an external frequency input – Models ET6000 and ET6010 only). It contains an RS-232 printer port. Optional features listed in Appendix C are available to meet specific requirements. Refer to the GPS Option/Connector Configuration sheet located in this manual for the options supplied with this instrument. The Option Descriptions are located in Appendix C.

Note: The GPS antenna and cable described in this manual have been replaced as described in "Appendix D: Antenna Replacement Kit" on page D-1.

CHAPTER ONE

1.4 SPECIFICATIONS

The electrical, physical, and environmental specifications for the ExacTime are listed below.

1.4.1 GPS SUBSYSTEM

A. TIME ACCURACY

After power-up, when LOCKED and using 200 Position Averages, will be better than ± 125 nanoseconds relative to UTC with SA on within:

4 hours using a Rubidium oscillator.

2 hours using an Oven oscillator.

1 hour using a TCXO oscillator.

B. FREQUENCY ACCURACY

90% of the time, better than: 1E-9 for TCXO

1.5E-10 for Oven (OCXO)

1E-11 for Rubidium

C. POSITION ACCURACY

100m 2dRMS with SA

Less than 25m SEP without SA.

D. MAXIMUM VELOCITY

515 meters/second. (1000 knots/hour).

E. TRACKING CHANNELS

Eight parallel.

F. RECEIVER FREQUENCY

L1 1.575 GHz, C/A Code.

G. ACQUISITION TIME

Time to first fix is less than 5 minutes with timing accuracy better than two μ S and frequency accuracy better than 1E-8. Full system accuracy with oven (OCXO) oscillator is provided within 2 hours after LOCKED.

1.4.2 TIMING OUTPUTS

Rear panel BNCs J4 through J9 can output a 10MHz sine wave, IRIG B (AC), various pulse rates, or alarm outputs. The following is the standard output configuration for the rear panel BNC connectors. To change the outputs from the factory set standard configuration, see the paragraph titled "Timing Outputs" in Chapter Two and the paragraph titled "Optional Pulse Rate Outputs" in this section of the User's Guide. Each output is via a 50 Ω driver.

A. J4 - TRACKING

This CMOS output level is “low” when the unit is actively acquiring data from satellites. In the Stationary Mode, the unit has to track at least one satellite for the Tracking level to go “low”. In the Dynamic Mode, the unit has to track at least four satellites, for the Tracking level to go “low”, and all available satellites are used for the time solution. The Tracking level is “high” when the unit is not acquiring data from any satellite or the satellites are not used for the time solution (as in the Flywheel Mode).

B. J5 - LOCKED

When this CMOS output level is “low” (LOCKED), the 1pps output is coherent to the internal 10MHz Oscillator. The DAC voltage controls the 10MHz oscillator from which the 1PPS is derived. When this CMOS output level is “high” (i.e., not locked), the 1pps is constantly being corrected (jammed) to on time using the 1PPS from the GPS Receiver Module. In this mode, the 1PPS output can jump.

C. J6 - 1PPS

This output is a thirty to fifty μ sec wide pulse at CMOS levels. The rise and fall times are ≤ 6 nanoseconds. It is positive (rising) edge on time, within ± 125 nanoseconds relative to either UTC or GPS with six or more satellite averaging with 95% confidence.

D. J7 - 10MHz SINE WAVE

This output has a nominal amplitude of one volt RMS into a 50 Ω load.

Note: The output amplitude of the 10MHz sine wave is dependent on the internal time base. This amplitude specification is for the Voltage Controlled Temperature Compensated Crystal oscillator.

J7 – COINCIDENCE OUTPUT (ET6500 ONLY)

The Preset Coincidence Pulse occurs 200 Nanoseconds late. Its pulse width is approximately two (2) microseconds wide, positive edge on-time. It is capable of driving 10 LSTTL loads.

To enable this output, on the GPS Main Assembly 100015, jumper J17 pins 7-8 (only). See Figure 2-3 in Chapter Two.

E. J8 - IRIG B (AC)

This output is Amplitude Modulated IRIG B122 Serial Time Code. This output is available only after the unit has tracked satellites and set time.

Carrier	1KHz
Modulation Ratio	3:1
Amplitude	Three volts peak-to-peak on the Mark Pulse

Note: When enabled, the unit will output a modified IRIG B per IEEE Std. 1344 that has data in the Control Function bit area. Refer to Table One at the end of this chapter for the Control Function Bit Assignments.

F. J9 - IRIG B (DC)

This output is Pulse Width Modulated IRIG B002 Serial Time Code at CMOS levels. This output is available only after the unit has tracked satellites and set time

G. J11 – PRINTER OUTPUT PORT

This DB9 connector can output data to an RS232 compatible serial printer or terminal.

It can be configured to operate in the Standard RS232 output or the One Second RS232 ASCII Burst Mode output. For the operation and configurations, refer to Chapters Three and Four.

H. OPTIONAL PULSE RATE OUTPUTS

The following is a list of optional pulse rate outputs available for selection on BNC connectors J4-J9. They are positive (rising) edge on-time. The majority of these rates have a 80/20 duty cycle with the exception of the 10MHz and the 5MHz which are square waves, and the 1PPM which is 40/20.

10MHz	5MHz	1MHz
100KHz	10KHz/2PPH*	1KHz
100Hz	10Hz/1PPH*	1Hz
.1Hz	1PPM	

Models ET6000 and ET6010 output 10KHz and 10Hz. Model ET6500 outputs 2PPH and 1PPH. For further clarification and/or configuration of the above outputs, See Chapters Two and Three.

1.4.3 ACCURACY

The accuracy of the pulse rates listed in Section 1.4.2H is the same as that in Section 1.4.1A.

1.4.4 TIMING INPUTS

A. **J10 - 1PPS INPUT (TIME INTERVAL MEASUREMENT) or EXTERNAL FREQUENCY MEASUREMENT or SINGLE EVENT LOG**

TIME INTERVAL MEASUREMENT

Used to measure the time interval between the internally generated GPS 1PPS and an external 1PPS input. The resolution of this measurement is 1 nanosecond with accuracy better than 10 nanoseconds. At power-up, this feature is DISABLED. If enabled, the measurement is displayed on the Second Menu Screen. Refer to Chapter Three. Also see paragraphs entitled, "Enable Time Interval," "Disable Time Interval," and "Request Time Interval," in Chapter Four of this User's Guide.

EXTERNAL FREQUENCY MEASUREMENT (MODELS ET6000 AND ET6010 ONLY)

Frequency Range

1Hz to 10MHz (discrete, whole numbers - not fractional parts).

Input Wave Form From 1Hz to 10MHz

Rectangular or square wave (minimum pulse width fifty nanoseconds).

Amplitude Range:

Logic "0" +0.2V \pm 0.2VDC

Logic "1" +2.4V to +15VDC

Input Wave Form From 100KHz to 10MHz

Sinusoidal Amplitude Range: 1 - 5 volts peak-to-peak

SINGLE EVENT LOG

This option provides the capability of logging the time occurrences of up to 256 events from one input. A pulse on the event input will cause the time to be logged/stored on either the rising (positive going) or falling (negative-going) edge of the input pulse. The edge designated as on time is programmable via the front panel keyboard or remotely via the RS-232 I/O. Each event will have a defining number from zero to 255 and the channel identifier.

CHAPTER ONE

The event memory can be read and/or cleared via the RS-232 I/O. Refer to Chapter Four of this User's Guide. If the inputs exceed 256 events (occurrences), the new data will be lost. If two events occur less than ten milliseconds apart, it is possible that one of the events may be lost. This will be reported as a missed event in the status code when the data is output. This event log option can also be enabled or disabled. Refer to Chapter Four of this User's Guide.

The event time resolution is from hundreds of nanoseconds through hundreds-of-days.

1.4.5 J12 RS-232 I/O INTERFACE

Full remote control of all operating functions in a complete ASCII protocol. Baud rate, parity, word length, and stop bits are selectable. See paragraph titled, "Fourth Menu Screen – RS232 I/O Configuration" in Chapter Three of this User's Guide. A description of the remote control functions is contained in Chapter Four.

1.4.6 INTERNAL TIME BASE

This unit can have one of three internal time bases depending on customer requirements. Unless otherwise specified, the following are the specifications for the oscillators used as the internal time base - not the specifications of the unit's 10MHz sine wave output.

A. VOLTAGE CONTROLLED TEMPERATURE COMPENSATED CRYSTAL OSCILLATOR (Configuration –TCXO) with the following specifications:

OUTPUT FREQUENCY/WAVEFORM

10MHz Sine Wave.

OUTPUT AMPLITUDE OF CRYSTAL OSCILLATOR

1.0 volt peak-to-peak minimum clipped sine wave into 20K Ω load. Harmonics - 20dBc maximum.

AGING RATE

1E-7 per day or \pm 1.0PPM maximum per year.

PHASE NOISE

The following specifications are for the 10MHz sine wave output available on rear panel BNC connectors J4-J9:

1Hz	-72 dBc/Hz
10Hz	-93 dBc/Hz
100 Hz	-115 dBc/Hz
1KHz	-126 dBc/Hz
10KHz	-136 dBc/Hz
100 KHz	-136 dBc/Hz

TEMPERATURE RANGE AND STABILITY

±1.0PPM from -30° to +75°C.

ADJUSTMENT RANGE

±3.0PPM minimum by internal manual trimmer.

VOLTAGE CONTROL

±3.0PPM minimum from +0.5 to +4.5 VDC.

B. LOW NOISE OVEN OSCILLATOR (Configuration –OCXO) with the following specifications:

OUTPUT FREQUENCY/WAVEFORM

10MHz Sine Wave.

OUTPUT AMPLITUDE OF CRYSTAL OSCILLATOR

1.0 volt RMS into 50 ohms.

AGING RATE

±5 x 10⁻¹⁰ per day, ±5 x 10⁻⁸ per year.

TEMPERATURE STABILITY

±1 x 10⁻⁸ over a temperature range of -20°C to +75°C.

OPERATING TEMPERATURE

-20°C to +75°C.

ALTITUDE

Sea level to +50,000 feet.

ELECTRICAL TUNING

±1PPM (minimum) / ±2PPM (maximum).

CHAPTER ONE

CONTROL VOLTAGE

0 to +6 volts.

MECHANICAL FREQUENCY ADJUST

± 1 PPM (minimum) / ± 3 PPM (maximum).

The following specifications apply to the selected 10MHz sine wave output at a +13 dbm level:

HARMONICS

-45 dBc

SPURIOUS NOISE

>-70 dBc

PHASE NOISE

1Hz	-100 dBc/Hz
10Hz	-120 dBc/Hz
100Hz	-140 dBc/Hz
1KHz	-144 dBc/Hz
10KHz	-144 dBc/Hz
100KHz	-144 dBc/Hz

C. RUBIDIUM OSCILLATOR (either X72 or LPRO) with the following specifications:

OUTPUT FREQUENCY/WAVEFORM

10MHz Sine Wave.

OUTPUT AMPLITUDE OF OSCILLATOR

0.55VRMS \pm 0.05VRMS into 50 ohms.

AGING RATE

$\leq 5 \times 10^{-11}$ per month, 5×10^{-10} per year.

OPERATING TEMPERATURE

-20°C to +70°C measured at the base plate.

STORAGE TEMPERATURE

-55°C to +85°C

ALTITUDE

-200 feet to +40,000 feet (operating).

FREQUENCY CONTROL - INTERNAL TRIM RANGE

$\pm 1.5 \times 10^{-9}$

FREQUENCY CONTROL - EXTERNAL (ELECTRICAL) TRIM RANGE

$\pm 1.5 \times 10^{-9}$ (0V to +5V).

The following specifications apply to the selected 10MHz sine wave output at a +13 dbm level:

HARMONICS

-42 dBc

SPURIOUS NOISE

>-80 dBc

PHASE NOISE

1Hz	-82 dBc/Hz
10Hz	-91 dBc/Hz
100Hz	-131 dBc/Hz
1KHz	-144 dBc/Hz
10KHz	-146 dBc/Hz
100KHz	-147 dBc/Hz

1.4.7 PRIMARY POWER

Models ET6000 and ET6010 utilize a Power Entry Module and the Standard Power Supply.

Input Voltage	AC = 85 to 264 VAC (47-440 Hz) @ less than thirty watts. DC = +120 to 373 VDC
Input Frequency Range	47 to 440 Hz

Note: When using 120 VAC, install 1 Amp Line Fuses. When using 220 VAC, install ½ Amp Line Fuses. Fuses are found in the Shipping Kit.

Model ET6500 utilizes a Power Entry and Alarm Relay Module (Assembly 55191) and the Standard Power Supply.

This module takes a nominal input of 115 VAC or 125 VDC through a rear panel terminal strip and provides +5 and ±12 VDC to power the GPS Time Code and Frequency Generator. It provides timing and fault status relay closures.

CHAPTER ONE

It also has the capability of measuring the frequency, phase angle, and elapsed time offset of an externally applied 50 or 60Hz AC sine wave.

Input Voltage	AC = 85 to 264 VAC (47-440 Hz) @ less than thirty watts. DC = +120 to 373 VDC
Input Frequency Range	47 to 440 Hz
Fault Relay	Closure on fault.
Timing Relay	Closure when not locked.
Relay Contact Ratings	10 watts, 0.5 amps, 200 volts.
50/60Hz Measurement Input	85-250 VAC.

Note: When using 120 VAC, install 1 Amp Line Fuses. When using 220 VAC, install ½ Amp Line Fuses. Fuses are found in the Shipping Kit.

All input/outputs from the 55191 are from a rear panel terminal strip TB1.
All input/outputs have metal oxide varistors for transient voltage suppression.
The pin assignments for TB1 are shown below (as viewed from the rear of the unit):

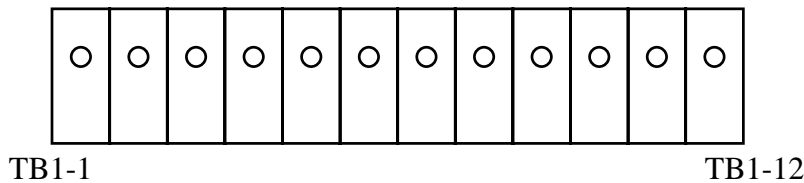

Pin Assignments

TB1-1	AC HI Input
TB1-2	AC LO Input
TB1-3	Chassis Ground
TB1-4	Fault Relay - Common Contact
TB1-5	Fault Relay - Normally Closed Contact
TB1-6	Timing Relay - Common Contact
TB1-7	Timing Relay - Normally Closed Contact
TB1-8	50/60Hz Measurement Input - HI
TB1-9	50/60Hz Measurement Input - LO
TB1-10	Not Used
TB1-11	Not Used
TB1-12	Not Used

This Power Entry and Alarm Relay Module has two relay closures to indicate timing/fault of the unit. The fault relay output on the rear panel terminal strip TB1-4 and 5 will provide contact closure upon the following conditions:

A processor error, from the GPS Receiver Module

Loss of +5VDC.

If the DAC value goes below 300 or above 65,000.

The timing relay (output on the rear panel terminal strip TB1-6 and 7) provides a contact closure until the unit has achieved oscillator lock. For example, until the front panel LOCKED LED illuminates.

1.4.8 DIMENSIONS

Chassis:

Height	1.75 Inches. Model ET6010 is 3.50 Inches.
Width	17 Inches.
Depth	12 Inches Maximum.

1.4.9 WEIGHT

ExacTime Unit	Approximately ten pounds.
Antenna/Preamp	Less than 1.5 pounds.

1.4.10 ENVIRONMENT

A. OPERATING TEMPERATURE

ExacTime Unit:	0°C to +50°C.
Antenna/Preamp:	-40°C to +85°C.

B. STORAGE TEMPERATURE

ExacTime Unit:	-20°C to +70°C.
Antenna/Preamp:	-55°C to +100°C.

C. HUMIDITY

ExacTime Unit	95% (non-condensing) up to 40°C.
Antenna/Preamp	Unlimited.

CHAPTER ONE

1.5 ADDITIONAL SPECIFICATIONS

The following is additional information regarding the GPS RPU (Receiver Processing Unit) located within the GPS Time Code and Frequency Generator, and the antenna/preamp.

1.5.1 ANTENNA/PREAMP

The antenna/preamp satisfies performance requirements at altitudes of up to +59,000 feet.

1.5.2 GPS RPU AND ANTENNA

The GPS RPU (Receiver Processor Unit) and antenna/preamp set has burn-out protection which prevents damage from an RF signal at power densities of up to one watt at the antenna. The RF signal must be 100MHz out of band. The C/A band of 1575.42MHz has a bandwidth of 20.48MHz.

1.6 FUNCTIONAL CHARACTERISTICS

The following is a description of the functional characteristics of the GPS RPU.

1.6.1 ACQUISITION

The GPS RPU position fix, acquisition and tracking processes feature the ability to determine its own position (that of the antenna/preamp), not the TC&FG Module, utilizing a position averaging technique and assuming the unit has been set to the "AUTO," or "DYNAMIC" mode. See "Third Menu Screen" in Chapter Three of this User's Guide for selection and an explanation of each MODE SELECTION using the front panel LCD and Keyboard. Mode selection may also be made via the RS-232 Interface. See the paragraph titled "Select Mode" in Chapter Four for mode selection using the RS-232 I/O.

The GPS RPU has an eight parallel channel design capable of tracking eight satellites simultaneously. The module receives the L1 GPS signal (1575.42 MHz) from the antenna and operates off the coarse/acquisition (C/A) code tracking. The code tracking is carrier aided. Time recovery capability is inherent in the architecture. The GPS RPU is designed specifically for precise timing applications.

Upon powering up the system, the unit begins a systematic search for satellites which are expected to be above the horizon. In this start-up mode of operation it uses the last position data stored in the battery backed RAM as a starting point. If it is in the A (Auto) mode, it will begin doing a running average of position fixes. After 200 averages, the unit will have acquired its position and will switch automatically to the S (Stationary) mode. The number of position averages is user selectable via the RS-232 I/O. See paragraph titled "Number of Averages" in Chapter Four.

If in the D (Dynamic) mode, the unit will use the last position data stored in battery backed RAM as a starting point to begin its systematic search for satellites. It will continue to do three dimensional position fixes (latitude, longitude, and altitude) upon acquiring four or more satellites until the mode is changed. If in the "STATIONARY" mode and a known position has been entered, the unit will use the position information stored in battery backed RAM as a starting point to begin its systematic search for satellites.

1.6.2 SIGNAL INTERRUPTION

During GPS ExacTime operation, should the signal from the satellites be interrupted, the antenna disconnected or blocked, the reacquisition time is dependent upon events during the interruption. For the first minute of the interruption, the GPS RPU continues to search for the last satellite signals to which it was locked. If the signal is regained during this minute, reacquisition will be almost immediate if the users velocity has not changed by more than fifty meters per second.

If the velocity has changed, the Doppler frequency has shifted. The GPS RPU must finish its search of previous satellite signals and will then expand the search to reacquire. The search time will depend on the amount of velocity change, but it is usually within fifteen seconds.

If the signal is regained within one minute, the expanding frequency search will already have begun cycling. In this case, reacquisition may require a few minutes depending upon where the RPU is in the frequency search when the signal is regained.

If the signal is regained within one hour, the same search must take place, then the new ephemeris data must be collected. In this case, reacquisition will occur within a few minutes.

The user should realize that obstructions, shading of the antenna, and satellite transmission interruptions can degrade the signal reception and length of acquisition times.

1.6.3 POSITION AND VELOCITY SOLUTION

The position and velocity, along with the time tag of the measurement, are digitally output from the RPU to the GPS ExacTime Processor. The position data is three dimensional and available in a latitude, longitude, and altitude (WGS-84) coordinate frame. The GPS solutions are computed at typically less than one second intervals.

CHAPTER ONE

1.6.4 DYNAMIC CAPABILITY

The following specifications are operational dynamic limits for GPS Timing Unit operation.

A. VELOCITY

The velocity of the user is limited to 515 m/sec for proper GPS Receiver operation.

B. ACCELERATION

User acceleration cannot exceed four 4g (39.2 m/sec²).

C. JERK

The rate of change of acceleration is not to exceed 5 m/sec³.

1.6.5 RF JAMMING RESISTANCE AND BURN-OUT PROTECTION

The GPS RPU provides resistance to all forms of jamming whose effect results in jamming to signal power ratios of twenty-four dB or less as measured at the antenna/preamplifier interface when the input signal is at -163 dBm. The GPS RPU/antenna set provides burn-out protection to prevent damage at RF power densities up to one watt (CW) at the antenna, provided the signal is 100MHz out of the GPS frequency band.

1.6.6 SYSTEM STATUS AND DIAGNOSTICS

All digital circuitry is tested to the greatest extent possible at power-up. This includes testing the memory systems, and processor, as well as monitoring the performance of the channel processors. Should a failure occur in any of these areas, it will be available as status on the RS-232 I/O and will be displayed on the LCD Display as an error.

1.6.7 GPS POSITION SOLUTION MODES

The user may select either the Auto Mode or the Dynamic Mode for position solutions. (In the Stationary Mode, the position is already predetermined.) See SELECT MODE in Chapter Three for front panel LCD and keyboard selection. See Chapter Four for MODE SELECTION using the RS-232 I/O.

The AUTO mode is actually a combination of the DYNAMIC and the STATIONARY modes. When powered up in the AUTO mode, the unit will acquire some number of positions in the DYNAMIC mode calculating an average latitude, longitude, and altitude when there are at least four satellites in view. The factory set default number of averages is 200. These position averages are loaded into battery backed memory for future use.

The number of positions used to calculate the averages is user selectable via the RS-232 I/O interface. Once the average position has been determined, the unit will switch to the STATIONARY mode. The AUTO mode provides an averaged solution of the time information from as many satellites as the receiver is tracking.

In the DYNAMIC mode, the system will select the best available satellites based on PDOP (Position Dilution Of Precision) and provide a continuous navigational solution in three dimensions (latitude, longitude, and altitude). The DYNAMIC mode does not automatically switch to the STATIONARY mode.

1.6.8 ELEVATION MASK ANGLE

This mask is used to specify the elevation angle below which the use of satellites is prohibited. Signal integrity from satellites very low on the horizon can be degraded. Obstructions will block the signal. For land-based applications where there are local obstructions (foliage, buildings, etc.) system performance will be smoother with an elevation mask of fifteen to twenty degrees. For marine or aircraft applications, it is usually possible to use the satellites very close to the horizon, although the pitch/roll should be considered. The system default is that set by the user. Refer to Chapter Four, paragraph titled "ENTER ELEVATION MASK ANGLE" for instruction on selecting elevation mask.

Table One
Control Function Bit Assignments

IRIG B Positive ID	Control Bit #	Designation	Explanation
P50	1	Year, BCD 1	Last two digits of year in BCD.
P51	2	Year, BCD 2	IBID.
P52	3	Year, BCD 4	IBID.
P53	4	Year, BCD 8	IBID.
P54	5	Not Used	Unassigned.
P55	6	Year, BCD 10	Last two digits of year in BCD.
P56	7	Year, BCD 20	IBID.
P57	8	Year, BCD 40	IBID.
P58	9	Year, BCD 80	IBID.
P59	N/A	P6	Position identifier number six.
P60	10	Leap Second Pending (LSP)	Becomes 1 up to 59 s BEFORE leap second insert.
P61	11	Leap Second (LS)	0 = add leap second, 1 = delete leap second.
P62	12	Not Used	
P63	13	Not Used	
P64	14	Time Offset Sign	Time offset sign 0 = +, 1 = -
P65	15	Time Offset - Binary 1	Offset from coded IRIG B time to UTC time. IRIG coded time plus time offset (including sign) equals UTC time at all times (offset will change during daylight savings).
P66	16	Time Offset - Binary 2	
P67	17	Time Offset - Binary 4	
P68	18	Time Offset - Binary 8	
P69	N/A	P7	Position identifier number.
P70	19	Time Offset - 0.5 Hour	0 = none, 1 = additional 0.5 h time offset
P71	20	Time Quality	4 bit code representing approx. clock time error 0000 = clock locked, maximum accuracy. 1111 = clock failed, data unreliable.
P72	21	Time Quality	
P73	22	Time Quality	
P74	23	Time Quality	
P75	24	PARITY	Parity on <i>all</i> preceding <i>data</i> bits.
P76	25	Not Used	Unassigned.
P77	26	Not Used	Unassigned.
P78	27	Not Used	Unassigned.
P79	N/A	P8	Position identifier number eight.

CHAPTER TWO

INSTALLATION

2.0 INTRODUCTION

This section describes the unpacking, inspection, and installation of the GPS Timing Unit.

2.1 UNPACKING AND INSPECTION

The GPS Timing Unit is packaged in one shipping container. Inspect the unit for visible damage (scratches, dents, etc.). If the instrument is damaged, immediately notify both Symmetricom Inc and the responsible carrier. Keep the shipping container and packing material for the carrier's inspection.

Note: When communicating with either Symmetricom Inc or the responsible carrier regarding shipping damage, refer to the serial number. This number is located on the rear panel of the GPS Timing Unit.

2.2 RACK MOUNTING PROCEDURE

The GPS Timing Unit is designed for standard nineteen inch rack mounting.

Optional chassis slides are recommended if the unit is to be installed in an equipment rack. If slides are not used, a supporting bar or tray should be provided for the rear of the instrument. The chassis slides attach to the sides of the GPS Timing Unit. To mount it using the optional slide mounting kit, use the eight #6 self tapping screws provided in the kit.

***** CAUTION *****

General Cautions/Hazards to be considered when installing the GPS Timing Unit into an equipment rack:

2.2.1 TMRA – The maximum recommended ambient temperature (Tmra) that this equipment is specified to operate in is 50°C.

2.2.2 ELEVATED OPERATING AMBIENT TEMPERATURE – If installed in a closed or multi-unit rack assembly, the operating ambient temperature of the rack environment may be greater than room ambient. Therefore, consideration should be given to installing the equipment in an environment compatible with the maximum rated ambient temperature (Tmra).

CHAPTER TWO

2.2.3 REDUCED AIR FLOW - The equipment has no cooling fans and depends on convection for cooling. Installation in a rack may cause an excessive heat rise if sufficient air flow is not available. Installation should be such that the amount of air flow required for safe operation of the equipment is not compromised.

2.2.4 MECHANICAL LOADING – Mounting of the equipment in the rack should be such that a hazardous condition is not achieved due to uneven mechanical loading.

2.2.5 CIRCUIT OVERLOADING – Consideration should be given to the connection of the equipment to the supply circuit and the effect that overloading of circuits might have on over current protection and supply wiring. Appropriate consideration of equipment nameplate ratings should be used when addressing this concern.

2.2.6 RELIABLE EARTHING – Reliable earthing of rack-mounted equipment should be maintained. Particular attention should be given to supply connections other than direct connections to the branch circuit (e.g., use power strips).

2.3 ANTENNA/PREAMP INSTALLATION

The antenna/preamp is enclosed in a weatherproof housing suitable for permanent installation in an exposed location. The unit should be located with an unobstructed view of the horizon for optimum tracking conditions. The signal will not penetrate foliage. Multi-path signals may be generated from vertical surfaces, which are above the plane of the base of the antenna/preamp.

The antenna/preamp, which is designed for fixed ground or marine applications, requires no special ground plane, but a large metal surface below the antenna/preamp may reduce multi-path effects. The unit may be mounted on any level surface or on a vertical pipe having ¾ - 14 NPT threads. See Figures 2-1, and 2-4, “Antenna/Preamp Installation,” for mounting.

***** CAUTION *****

A high powered radar beamed directly at the antenna/preamp may damage it and a signal within a few MHz of the carrier frequency may jam the GPS RPU.

2.4 ANTENNA/PREAMP INTERFACE CONNECTIONS

A fifty foot long RG-58A/U coaxial cable is provided to connect the antenna/preamp to the GPS Timing Unit. For cable lengths greater than seventy-five feet, an optional low loss coaxial cable (such as Belden 9913) must be used.

Note: The GPS antenna and cable described in this manual have been replaced as described in “Appendix D: Antenna Replacement Kit” on page D-1.

The antenna/preamp power is provided by the GPS Timing Unit via the coaxial cable. No additional cabling is required to power the antenna/preamp.

Cables attached to the antenna/preamp should be strain relieved and secured to some permanent fixture.

Cables attached to the antenna/preamp which are exposed to the elements should be wrapped with a weather-proof tape after being connected.

Cables from the antenna/preamp should be secured as required with cable clamps and should *not* put a strain on the antenna/preamp connector as it may damage the unit.

2.5 PRIMARY POWER CONNECTION

The GPS Timing Unit is operated from external AC power. The AC power specifications are listed in the specification section in Chapter One of this User’s Guide.

Models ET6000 and ET6010 utilize a power cord that plugs into a Power Entry Module.

Note: Check the AC line fuses located in the power entry module on the rear panel and assure the correct fuse is installed for the AC Line voltage being used to power the unit. The AC line fuses should be 1 Amp for an AC input of 120 volts or ½ amp for an AC input of 220 volts.

Model ET6500 utilizes a terminal strip Power Entry and Alarm Relay Module (Assembly 55191).

Note: Check the AC line fuses located in the power entry module inside the unit and assure the correct fuse is installed for the AC Line voltage being used to power the unit. The AC line fuses should be 1 Amp for an AC input of 120 volts or ½ amp for an AC input of 220 volts.

The terminal strip pin designations are shown below:

**REAR VIEW OF ET6500 SHOWING 55191
POWER ENTRY AND ALARM RELAY MODULE**

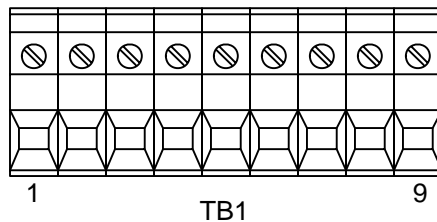

PIN ASSIGNMENTS

TB1 Pin 1	AC High Input
TB1 Pin 2	AC Low Input
TB1 Pin 3	Chassis Ground
TB1 Pin 4	Fault Relay – Common Contact
TB1 Pin 5	Fault Relay – Normally Closed Contact
TB1 Pin 6	Timing Relay – Common Contact
TB1 Pin 7	Timing Relay – Normally Closed Contact
TB1 Pin 8	50/60Hz Measurement Input - High
TB1 Pin 9	50/60Hz Measurement Input - Low

This assembly has two relay closures to indicate timing/fault of the unit. The fault relay output on the rear panel terminal strip TB1-4 and 5 will provide contact closure upon the following conditions:

A processor error, Channel One error, or Channel Two error from the GPS receiver.

Loss of +5VDC.

If the DAC value goes below 300 or above 65,000.

The timing relay output on the rear panel terminal strip TB1-6 and 7 provides a contact closure until the unit has achieved unit stabilization. For example, until the front panel LOCKED LED illuminates.

If this unit is provided with a power supply other than the standard, its specifications will be found in the Option Description envelope located on the inside cover of this User's Guide.

Figure 2-1
Antenna/Preamp Installation

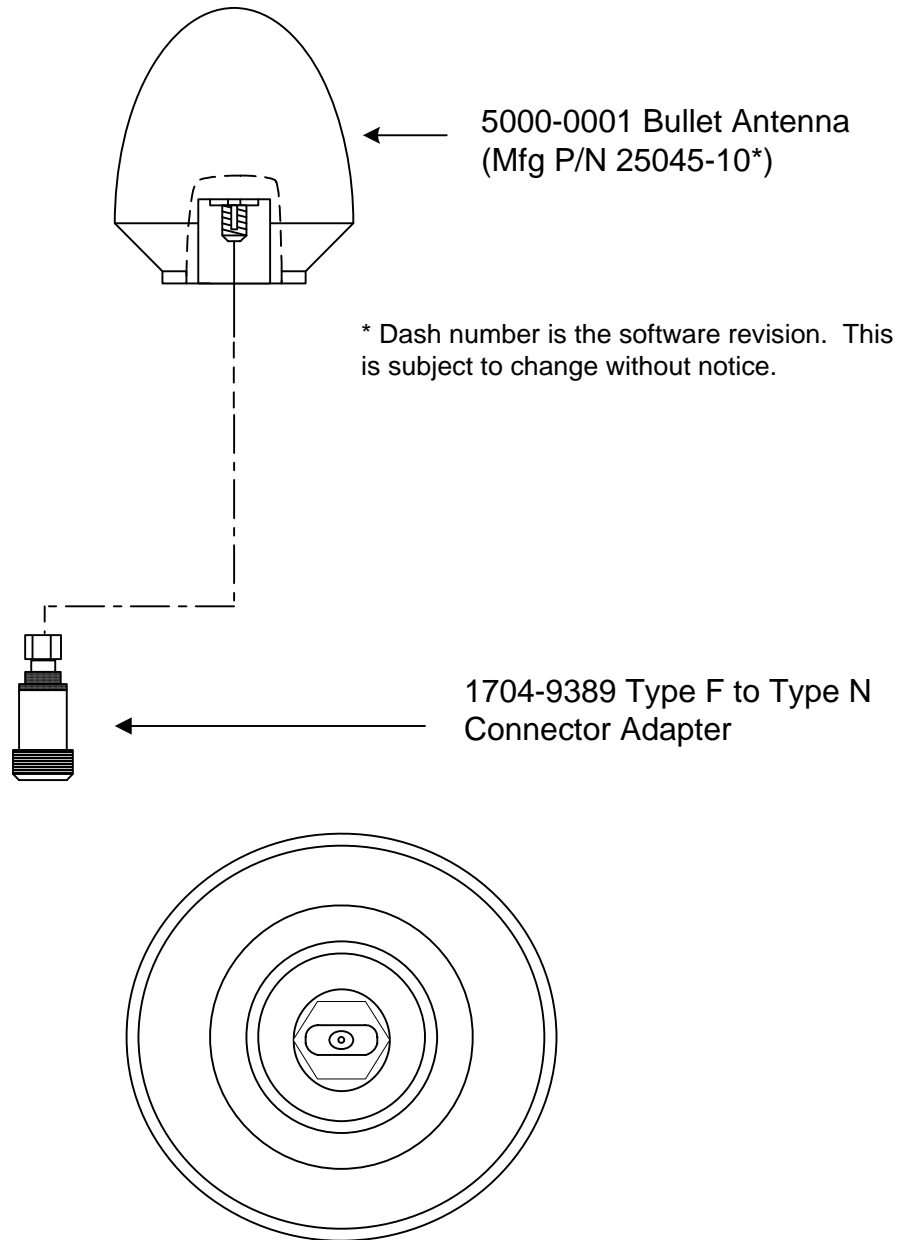

1. Material* PVC or CPVC Schedule 80, Gray Color.

Note: The GPS antenna and cable described in this manual have been replaced as described in “Appendix D: Antenna Replacement Kit” on page D-1.

2.6 GPS TIMING UNIT INTERFACE CONNECTIONS

The GPS Timing Unit interface connections consist of cabling to the antenna/preamp assembly from J2 on the unit's rear panel, the RS-232 I/O port J12 (if used), and the time and frequency inputs and outputs and/or other optional inputs or outputs.

2.6.1 RS-232 I/O INTERFACE J12

This port provides the basic read/write mode of operation.

Before connecting a peripheral device to this port, read the manual accompanying the product and be aware of the necessary precautions. Determine the BAUD rate, parity word length, stop bits, and interconnections with the equipment.

This I/O port is configured as a DCE, and is intended to be used by intelligent peripherals such as a computer. The RS-232 I/O port uses a standard DB-9 I/O connector with the pin configuration shown in Figure 2-2.

The RS-232 protocol is described in Chapter Four in the paragraph titled "Information."

Figure 2-2
RS-232 I/O Cable Pin Assignments

GPS ExacTime	Computer
1	1
2	2 RX
3	3 TX
4	4 DTR
5	5 GND
6	6 DSR
7	7 RTS
8	8 CTS
9	9

The RS-232 I/O interface uses a standard PC compatible one-to-one cable using nine Pin D type connectors. Handshaking is not used. Pin 6 (DSR) and pin 8 (CTS) on J12 are internally set high.

2.6.2 PRINTER OUTPUT PORT J11

This connector can output data to an RS232 compatible serial printer or terminal. It can be configured to output data in the Standard configuration or the One Second ASCII Burst Mode Output. Refer to Chapter Three (Tenth Menu Screen) for more specific details on configuration and operation.

Connector configuration:

1	—————	NOT USED
2	—————	INPUT LINE TO ET6XXX - NOT USED
3	—————	TX (Data Out)
4	—————	NOT USED
5	—————	GROUND
6	—————	NOT USED
7	—————	NO CONNECTION
8	—————	OUTPUT LINE FROM ET6XXX - NOT USED
9	—————	NOT USED

2.6.3 TIMING OUTPUTS

Various timing output signals can be provided on the rear panel BNC connectors J4 through J9. The selection of these outputs is made using jumper pins/blocks on the GPS Main Assembly 100015, as shown in Figure 2-3, and the front panel keyboard, or via the RS-232 I/O.

To check or reconfigure these outputs via the front panel keyboard, see the paragraph titled “Configuration of Rear Panel BNC Connectors J4-J9” in Chapter Three of this User’s Guide.

To check or reconfigure these outputs via the RS-232 I/O, see the paragraphs titled “Request MUX Outputs,” and “Set MUX Output” in Chapter Four of this User’s Guide.

The standard configuration is as follows:

J4 Tracking (TTL)*	Jumper J14 7 and 8, and J24 1 and 2.
J5 Locked (TTL)**	Jumper J15 7 and 8, and J25 1 and 2.
J6 1pps	Jumper J16 1 and 2.
J7 10MHz Sine Wave	Jumper J17 5 and 6.
J8 IRIG B (AC)	Jumper J18 3 and 4, and J28 1 and 2.
J9 IRIG B (DC)	Jumper J19 1 and 2, and J29 1 and 2.
J10 1pps Input	(Time Interval Measurement).

CHAPTER TWO

- * Tracking output is low when unit is tracking, high when unit is not tracking.
- ** Locked output is low when unit is locked, high when unit is not locked.

For additional pulse rate selections available on BNC connectors J4-J9, see Chapter One of this User's Guide.

Configurations other than the standard above will be found in the GPS Option/Connector Configuration Sheet located in this User's Guide.

2.6.4 1PPS INPUT

A 1pps pulse can be input on a rear panel BNC connector labeled J10. This input can be utilized when making time interval measurements between the internal corrected GPS 1pps and an external 1pps input pulse. This is a multipurpose input that may also be optionally utilized to record an event or accept a frequency for external measurement purposes.

2.6.5 OSCILLATOR CONFIGURATION

The jumper blocks at J27 enable the processor (and the program) to determine which oscillator is installed on the board. This provides for the selection of the specific gain and correction voltage (i.e. the discipline voltage) for each oscillator. The jumpers are factory set for the oscillator in your specific configuration, and shouldn't need to be changed unless the oscillator type is changed.

J27 OSCILLATOR CONFIGURATION

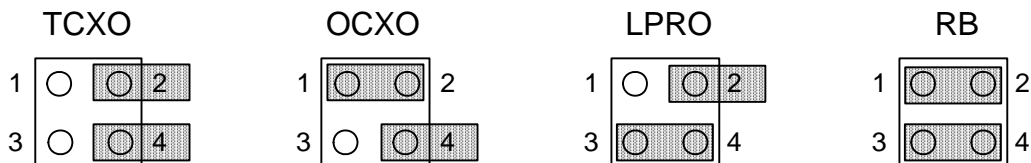

- For the TCXO, no jumpers are installed.
- For the OCXO, jumper pins 1-2.
- For the Rubidium LPRO, jumper pins 3-4.
- For the Rubidium X-72, jumper pins 1-2, and 3-4.

Figure 2-3
GPS Main Assembly 100015

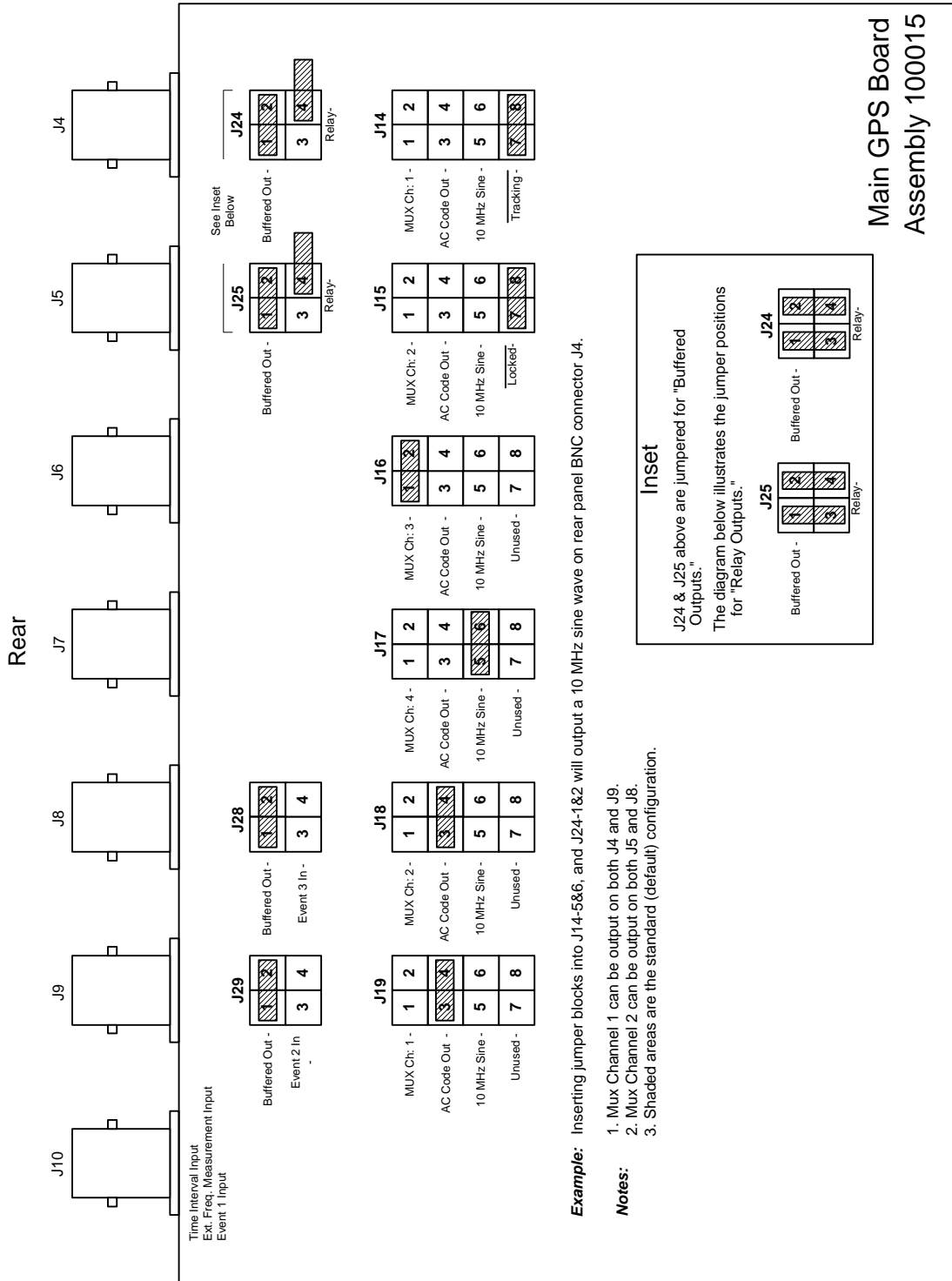

Example: Inserting jumper blocks into J14-5&6, and J24-1&2 will output a 10 MHz sine wave on rear panel BNC connector J4.

- Notes:**
1. Mux Channel 1 can be output on both J4 and J9.
 2. Mux Channel 2 can be output on both J5 and J8.
 3. Shaded areas are the standard (default) configuration.

Figure 2-4
Antenna/Preamp Installation

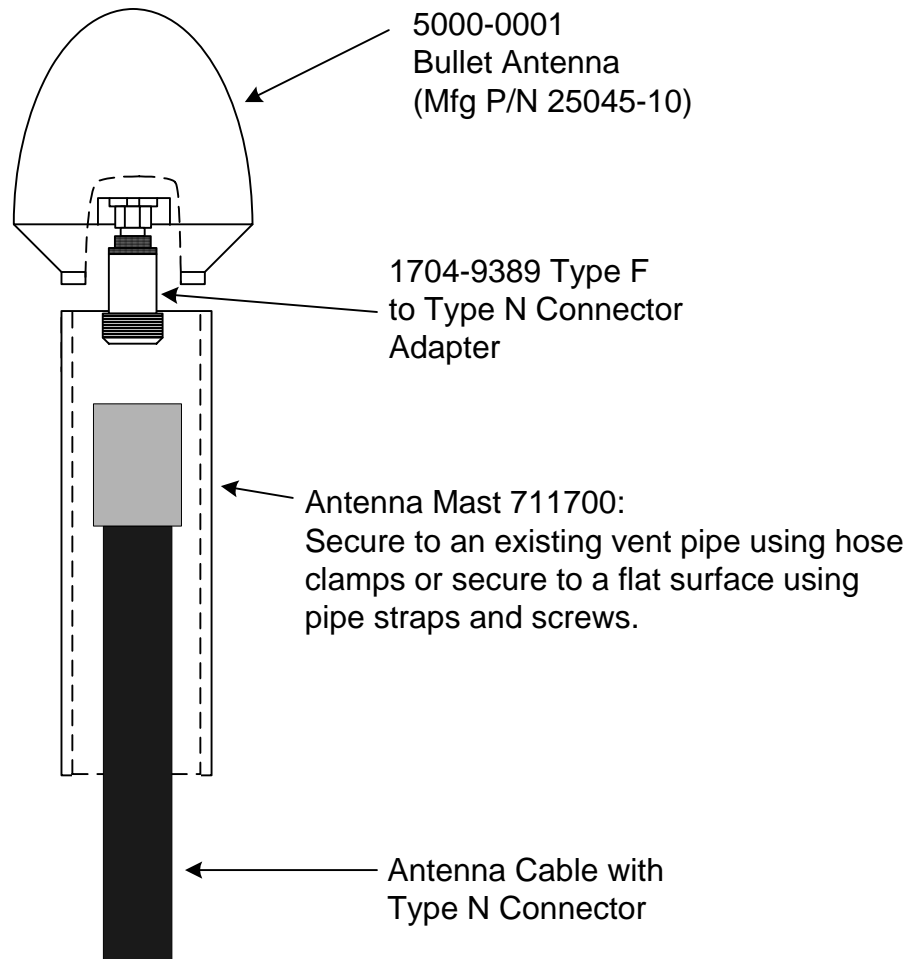

Note: The GPS antenna and cable described in this manual have been replaced as described in “Appendix D: Antenna Replacement Kit” on page D-1.

CHAPTER THREE

OPERATION

3.0 INTRODUCTION

This chapter describes the operation of the basic GPS ExacTime. Operating instructions for the optional features are contained Appendix C of this User's Guide.

Note: The GPS antenna and cable described in this manual have been replaced as described in "Appendix D: Antenna Replacement Kit" on page D-1.

3.1 OPERATIONAL STEPS

The following are the initial installation steps necessary for the operation of your unit:

- Connect the appropriate input/output cables and components including as a minimum the power cable, the antenna, and antenna cable.
- Apply power to the unit. Initially the front panel TRACKING and LOCKED LED's will flash and the POWER LED will illuminate. This signifies that the microprocessor and associated circuitry have been initialized correctly and are operating.
- At this point, the Operational Mode needs to be selected. See the section entitled "SET-UP MENU SCREEN – SET MODE" (this chapter). The criteria for selecting the various modes can be summarized as follows:

AUTO – Use if your position (i.e. the position of the antenna) is unknown, and stationary. This is the default mode. See section titled "Initialization (Unknown Position)."

DYNAMIC - This mode would be selected if the unit is mounted in a moving vehicle. By definition, your position is unknown. See section titled "Initialization (Unknown Position)."

STATIONARY - Use if your position is known, stationary, and accurately surveyed. See the section titled "Initialization (Known Position)."

FLYWHEEL – To use your unit as a time code generator only. Position is not determined and the internal oscillator is not disciplined.

3.1.1 INITIALIZATION (UNKNOWN POSITION)

- Set the SET MODE to "AUTO" if it is not already in the "AUTO" mode. The unit will then start to track satellites (refer to the Main Menu Screen – this chapter). When satellites are acquired and ready for time solution, the TRACKING LED will illuminate signifying that the unit is tracking satellites.

CHAPTER THREE

- The message “GPS Time Not Acquired” will be displayed until the unit receives the Leap Second information. At that point, the unit will set time and the message “ZZZZ Stabilizing XX” will be displayed.

ZZZZ = The internal 10MHz oscillator installed in the unit. Either TCXO, OCXO, LPRO, or X72. (LPRO and X72 are both versions of a Rubidium oscillator.)

XX = A number (10 to 1) indicating the progression through a series of oscillator stabilization steps.

- After the oscillator stabilization step is finished, the unit will begin doing position averaging in order to derive the position. The number of averages is set to the default number of 200 but is user selectable via the RS-232 I/O Interface. See paragraph titled “Number of Position Averages” in Chapter Four of this User’s Guide. A position fix takes approximately seven seconds, so the position averaging itself could take about 20 minutes.
- Once the unit has accomplished its position averaging, the unit will switch to the STATIONARY mode. At this time, the 1pps will be coherent with the internal disciplined 10MHz oscillator.
- Unit stabilizing will begin. The unit starts to discipline the internal oscillator. Once the unit’s discipline process has stabilized, the LOCKED LED will illuminate indicating that the unit is completely functional.

For a TCXO oscillator, this process will take about 30 minutes.

For a OCXO oscillator, this process will take about 90 minutes.

For a Rubidium oscillator, this process will take about 3.5 hours.

- If the LOCKED front panel LED does not illuminate within the specified time above, check the DAC value displayed on the POSITION MENU SCREEN, and/or the status displayed on the MAIN MENU SCREEN, or via the RS-232 I/O interface (see Chapter Four, paragraphs titled “Request DAC Value,” and “Print Time, Status, Error Code, and Satellite Vehicle Numbers” respectively). If DAC value number has approached either one of its extremes (00000 or 65535), the internal oscillator needs to be nulled/calibrated. Refer to the “Internal Oscillator Calibration” procedure in Chapter Five of this User’s Guide.
- If the unit stops tracking satellites at any point after initial power-up, the TRACKING LED will be turned off. At that time, an internal elapsed time counter will be started and the short term oscillator stability will be stored in memory. Based upon the type of internal 10MHz oscillator installed in the unit, the LOCKED LED will remain illuminated until the internal elapsed time counter has timed out.

For a TCXO oscillator, it will take about 30 minutes.
 For a OCXO oscillator, it will take about 60 minutes.
 For a Rubidium oscillator, it will take about 4 hours.

3.1.2 INITIALIZATION (KNOWN POSITION)

- Set the SET MODE to “STATIONARY” mode. See paragraph titled “Select Mode” under the SET-UP MENU SCREEN in this chapter for mode selection.

Enter the known position (latitude, longitude, and altitude) of the GPS antenna. (The GPS antenna described in this manual has been replaced as described in “Appendix D: Antenna Replacement Kit” on page D-1.)

-) See paragraph titled “Set Position” in this chapter.
- The unit will start to track satellites (refer to the Main Menu Screen – this chapter). When satellites are acquired and ready for time solution, the TRACKING LED will illuminate signifying that the unit is tracking satellites.
- The message “GPS Time Not Acquired” will be displayed until the unit receives the Leap Second information. At that point, the unit will set time and the message “ZZZZ Stabilizing XX” will be displayed.

ZZZZ = The internal 10MHz oscillator installed in the unit. Either TCXO, OCXO, LPRO, or X72. (LPRO and X72 are both versions of a Rubidium oscillator.)

XX = A number (10 to 1) indicating the progression through a series of oscillator stabilization steps.

- After the oscillator stabilization step is finished, unit stabilizing will begin. The unit starts to discipline the internal oscillator. Once the unit’s discipline process has stabilized, the LOCKED LED will illuminate indicating that the unit is completely functional.

For a TCXO oscillator, this process will take about 30 minutes.

For a OCXO oscillator, this process will take about 90 minutes.

For a Rubidium oscillator, this process will take about 3.5 hours.

- If the LOCKED front panel LED does not illuminate within the specified time above, check the DAC value displayed on the POSITION MENU SCREEN, and/or the status displayed on the MAIN MENU SCREEN, or via the RS-232 I/O interface (see Chapter Four, paragraphs titled “Request DAC Value,” and “Print Time, Status, Error Code, and Satellite Vehicle Numbers” respectively). If DAC value number has approached either one of its extremes (00000 or 65535), the internal oscillator needs to be nulled/calibrated. Refer to the “Internal Oscillator Calibration” procedure in Chapter Five of this User’s Guide.

CHAPTER THREE

- If the unit stops tracking satellites at any point after initial power-up, the TRACKING LED will be turned off. At that time, an internal elapsed time counter will be started and the short term oscillator stability will be stored in memory. Based upon the type of internal 10MHz oscillator installed in the unit, the LOCKED LED will remain illuminated until the internal elapsed time counter has timed out.

For a TCXO oscillator, it will take about 30 minutes.

For a OCXO oscillator, it will take about 60 minutes.

For a Rubidium oscillator, it will take about 4 hours.

3.2 OPERATIONAL CHARACTERISTICS

The standard internal time base is a voltage controlled temperature compensated 10MHz crystal oscillator. When the disciplining feature is ENABLED, its frequency is controlled/corrected to the internal GPS 1pps using a DAC (Digital to Analog Converter). Disciplining of the oscillator occurs only when it is ENABLED and used as the unit's time base, and when the GPS ExacTime is actively tracking a satellite. During periods when there are no satellites in view or when the unit isn't tracking, the last DAC value is retained, and the unit continues to operate normally. The outputs are then as accurate as the drift/aging rate of the oscillator. See Chapter Four, paragraphs titled "Enable Disciplining," and "Disable Disciplining" in this User's Guide for enabling and disabling disciplining.

Disciplining is ENABLED by default when the unit is powered.

3.3 LIQUID CRYSTAL DISPLAY

The front panel LCD Display contains two rows of forty characters per row. It displays at least ten separate MENU screens that are changed by pushing the front panel MENU keyboard switch.

3.3.1 MAIN MENU SCREEN

When power is first applied to the TC&FG, the LCD displays an Initial Menu Screen that contains the unit's ID followed by four digits that correspond to the serial number of the unit. After approximately 5 seconds, the display then switches to the Main Menu Screen.

Note: If you have just installed revised/upgraded firmware or performed a “Cold Reset” (see Chapter Five), an additional extra screen will be displayed in front of your Main Menu Screen. This screen will only appear the first time power is applied to your unit after a Cold Reset or the new firmware has been installed. After that, the normal Main Menu Screen will appear. This additional Initial Calibration screen is shown below:

Column:

	1	5	10	15	20	25	30	35	40	
Row 1	000	.00	:00	:12	<	DOING	TIME	INT.	CALIB.	>
Row 2	142	195	073			123	157	056	198	

This internal, automatic Time Interval Calibration is necessary to get accurate nanosecond time interval resolution for the measurement of the GPS and external 1PPS. In the example above, 142 and 123 are the current values, 195 and 157 are the high values, 073 and 056 are the low values, and 198 is the number of seconds remaining until the calibration is finished. This number starts at 250 and decrements to zero at a one second rate.

If the MENU key is pressed prior to completing the calibration process, the calibration will be interrupted and the process aborted. However, an additional menu screen (this Time Interval Calibration MENU) will be enabled. The user can access this screen if he cycles through the various menus by pushing the MENU key. This Calibration Menu screen will enable the nanosecond time interval calibration to be completed at a later date.

It is important to note that if this automatic time interval calibration is interrupted prior to its completion, it will be necessary to restart and complete it (using the TIME INTERVAL CALIBRATION MENU screen) or inaccurate time interval measurements will result.

The following is the normal MAIN MENU that is displayed. It contains the following information:

- Symmetricom Firmware Version.
- Synchronization.
- Time (Seconds through Days).
- Status and Error Messages.
- Frequency Offset.
- Satellite PRN Identification.
- Mode.

CHAPTER THREE

A sample of the MAIN MENU SCREEN is shown below:

	Column:	1	5	10	15	20	25	30	35	40																															
Row 1		1	2	3	4	5	6	7	8	9	10	11	12	13	14	15	16	17	18	19	20	21	22	23	24	25	26	27	28	29	30	31	32	33	34	35	36	37	38	39	40
		1	2	3	4	5	6	7	8	9	10	11	12	13	14	15	16	17	18	19	20	21	22	23	24	25	26	27	28	29	30	31	32	33	34	35	36	37	38	39	40
Row 2		1	2	3	4	5	6	7	8	9	10	11	12	13	14	15	16	17	18	19	20	21	22	23	24	25	26	27	28	29	30	31	32	33	34	35	36	37	38	39	40

At power up, the type of oscillator installed in the unit and the software version appear on the first row of the LCD display. The oscillator can be a TCXO, OCXO, LPRO, or X72 (LPRO and X72 are Rubidium oscillators). The software version appears as DTxxxxxx, where DTxxxxxx is the Operational Software Version.

The time-of-year is displayed in Row One, starting with Column One and consists of day-of-year, hour, minute, and second. This can be UTC, or GPS time, or display the local time offset depending on which mode has been selected via the RS-232 I/O port, or via the front panel LCD and keyboard. For remote selection, see the paragraph titled “UTC Sync” to select UTC time synchronization, and the paragraph titled “GPS Sync” to select GPS synchronization in Chapter Four of this User’s Guide. For local selection, refer to the paragraph titled “Set Time,” under SET-UP MENU SCREEN in this section, to select UTC or GPS synchronization using the front panel LCD and keyboard. See paragraph titled “Enter Local Time Offset” in Chapter Four of this User’s Guide to enter the desired local time offset via the RS-232 I/O port. The local time offset may also be entered into the unit using the front panel keyboard and LCD. See paragraph titled “Local Time Offset” under the SET-UP MENU SCREEN in this chapter.

The letter “U” or “G” which is displayed in Row One, Column Fourteen, denotes whether UTC (U) or GPS (G) synchronization has been selected. An extra letter “L” is displayed next to the letter “U” or “G” if the local time offset is not equal to zero. An “L” indicates that the time is offset by a Local Time Offset.

When the GPS TC&FG is synchronized to UTC time, the time-of-year is displayed and the GPS corrected 1pps output is on-time with UTC within ± 125 nanoseconds with SA (Selective Availability).

When the GPS TC&FG is synchronized to GPS time, there is a time difference between UTC and GPS time. As of 9 September, 2000, the difference was thirteen seconds because of the leap second difference. Leap seconds are added to or subtracted from UTC time, but not GPS time.

Status and error messages are displayed in Row One, starting at Column Fifteen. The status and error messages alternate every ten seconds. At initial power-up, this area will display the Symmetricom firmware version for a few seconds.

The possible status messages displayed are:

Doing GPS Corrections.
 GPS Time Not Acquired.
 PDOP is Too High.
 No Usable Satellites.
 Position Survey XXXXX
 ZZZZ Stabilizing XX.
 Unit Stabilizing XXX
 Flywheel Mode.

The “STATUS CODES” are via the RS-232 I/O when requested, and output by the printer port if the option is implemented. The characters S00 through S15 are printed for the status.

The status message, “DOING GPS CORRECTIONS” is an indication that the GPS Unit is performing the tasks appropriate to the selected mode of operation. The operational modes include AUTO, DYNAMIC, STATIONARY, and FLYWHEEL selections. The various modes will be detailed in subsequent sections of this User’s Guide and are listed here only to aid in understanding of the “STATUS MESSAGES.”

The status message “PDOP IS TOO HIGH” indicates that the Position Dilution Of Precision (PDOP) exceeds a limit.

The status message, “NO USABLE SATELLITES” is similar to the “DOING GPS CORRECTIONS” status message, except that the GPS Time has been previously acquired and has been maintained to at least the oscillator reference precision since the last usable satellite was visible. Refer to the paragraph titled “Set Mode (Mode Selection)” in this chapter.

The status message “ZZZZ Stabilizing XX,” where the two digit number (ten to 00) following “ZZZZ Stabilizing” represents how far away the oscillator is from stabilization. At power on it will be ten and then down count to 00. The length of time the unit has been OFF and the ambient temperature will affect how long the oscillator takes to stabilize. Refer to paragraph titled “Operational Steps” in this chapter. The “ZZZZ” indicates the type of oscillator installed in the unit. It can be a TCXO (Temperature Controlled Crystal Oscillator), an OCXO (Oven Controlled Crystal Oscillator), an LPRO (Low Profile Rubidium Oscillator), or an X72 (Rubidium Oscillator).

The status message “Position Survey XXXXX” where the five digit number after the message “Position Survey” represents the number of averages remaining before the LOCKED LED will illuminate. The number starts at the maximum number programmed (default is 200) and counts down to 0000. This message is applicable only in the AUTO MODE of operation. Refer to the paragraph titled “Number of Position Averages” for selection of number of averages.

CHAPTER THREE

The status message “Unit Stabilizing XXX” is displayed during the Unit Stabilization process. The XXX is a three digit number that represents (in minutes) how far the unit is from being LOCKED.

The status message “Flywheel Mode” is displayed if the Flywheel Mode has been selected. Refer to the paragraph titled “Set Mode (Mode Selection)” in this chapter.

The possible Error Messages displayed are:

Character	Definition
E00	System Check OK.
E02	Processor Failure.
E04	Ant. Undercurrent
E08	Ant. Overcurrent

The character error codes are for the RS-232 I/O port and optional printer port outputs.

The “Error Codes” are provided for the same reason as the “Status Codes” in the previous paragraph.

The error message “System Check OK” is displayed when there are no problems with the system and “all is well.”

The error message “Processor Failure” indicates a signal processor error has been detected. After this error is detected, it will remain until the receiver is reset.

The error message “Ant. Undercurrent” indicates that the GPS RPU is not providing sufficient current to the antenna. The probable cause of this message is a discontinuity in the antenna cable or a failure of the antenna/preamp itself. Check the antenna/preamp cable connections since they are the most likely cause of the discontinuity.

The error message “Ant. Overcurrent” indicates that the GPS RPU is providing too much current to the antenna. The probable cause of this message is a short in the antenna cable or a failure of the antenna/preamp itself. Check the antenna/preamp cable connections since they are the most likely cause of the short.

The frequency offset is displayed in Row Two starting with Column One. This offset is the calculated difference between the units local time base and the GPS System frequency. It consists of either a plus (+) or minus (-) followed by a four digit number expressed in parts to 10^9 or 10^{-12} (the E-exponent).

Note: The GPS antenna and cable described in this manual have been replaced as described in “Appendix D: Antenna Replacement Kit” on page D-1.

The satellite PRN identifications are displayed in Row Two starting with Column Fifteen. These are the SV numbers that the unit is currently tracking. They can consist of up to four two digit numbers.

The mode is displayed in Row Two starting at Column Thirty-One. A character, which indicates the mode is followed by a number, which indicates the number of satellites, which are in view of the antenna. "A" represents AUTO mode, "D" represents DYNAMIC mode, "S" represents STATIONARY mode, and "F" represents FLYWHEEL mode.

3.3.2 POSITION MENU SCREEN

Depressing the MENU keyboard switch once will display this screen. This screen contains the following information:

- Latitude, Longitude, and Altitude.
- PDOP Value.
- GPS Week Number.
- Year.
- DAC Value.
- Time Interval.

Note: Depressing the MENU keyboard switch and continuously holding it down for more than two seconds will display the previous menu screen.

A sample of the Position Menu Screen is shown below:

	1	5	10	15	20	25	30	35	40
Row 1	33°48.8241N 117°53.3970W +0026M PDOP:09								
Row 2	WK:0698 YR:98 DAC:32767 INT:340276.512µS								

Latitude, expressed in Degrees, Minutes, N (North), or S (South) is displayed in Row 1 starting at Column 1. It is followed by Longitude expressed in degrees, minutes, W (West), or E (East). Next is the altitude, starting with a plus (+) or minus (-) followed by four digits expressed in meters. If the unit is in the DYNAMIC mode and actively tracking more than four satellites, the PDOP value is shown in Row One starting at Column thirty-three. It is a two digit value which reflects the geometry of the satellites currently being tracked.

The four digit GPS week number is displayed at the start of Row Two.

CHAPTER THREE

The two digit year (YR) is shown in Row Two starting at Column Nine. Starting at Column Sixteen of Row Two is the DAC, a 5 digit (00000 to 65535) number which is a digital representation of the analog voltage (0 to +5volts) that controls/disciplines the internal 10MHz oscillator.

The last data displayed in this screen is the Time Interval (INT) which is an example of the time interval measurement between the 1PPS output and an externally supplied 1PPS input.

Time Interval Measurement is operational in the AUTO, DYNAMIC, and STATIONARY modes when “LOCKED” with the following qualification: If after achieving “LOCKED” the unit loses satellites and the “TRACKING” and “LOCKED” LEDs go out, this function will still be operational until satellites are reacquired. At that point, it won’t be operational again until “LOCKED” has been achieved. This function is always available in “FLYWHEEL” mode.

3.3.3 SET-UP MENU SCREEN

Subsequent pushing of the MENU keyboard switch will display the Set-up Menu Screen which is shown below and contains the following choices:

	Column:	1	5	10	15	20	25	30	35	40
Row 1		1>SET	MODE	3>SET	POSITION	5>OFFSET	00.0H			
Row 2		2>SET	TIME	4>SIGNAL	LEVEL	6>SET	DAC			

If the #0 keyboard switch is pressed, the operational software version and the current Leap Second will appear in the lower right-hand corner (in place of “SET DAC”).

A. 1> SET MODE (MODE SELECTION)

To set the mode, press the #1 keyboard switch. The display will change to that as shown below:

```
0>AUTO 1>STATIONARY 4>DYNAMIC 5>FLYWHEEL  
OPERATING MODE: AUTO
```

Choice “0>AUTO”

Depressing the “0” keyboard switch selects the “AUTO” mode. Pressing the MENU keyboard switch will return the display to the SET-UP MENU SCREEN. The “AUTO” mode uses four satellites. If more than four satellites are in view and useable, a set of four based on optimal satellite (minimum PDOP) geometry is automatically selected for use.

In this mode, after an initial warm-up delay, and an oscillator stability check/delay, the unit will be in the Dynamic mode and will begin doing position averaging. The position average is actually a running average of each subsequent position value. The number of averages is user selectable but the default number is 200. A position fix takes approximately three seconds, so the position averaging itself could take about ten minutes.

Once the unit has completed its position averaging, it will switch to the Unit Stabilizing mode. At this time, the 1pps will be coherent with the internal disciplined 10MHz oscillator, and the oscillator discipline process begins. At the end of Unit Stabilizing, the front panel LOCKED LED will illuminate.

For additional information on the “AUTO” mode, see Chapter Five.

Choice “1>STATIONARY” (Timing Mode)

Depressing the “1” keyboard switch selects the “STATIONARY” Mode. Pressing the MENU keyboard switch returns the display to the SET-UP MENU SCREEN.

The “STATIONARY” (Timing) mode is the most frequently used mode of operation for timing applications. This mode of operation assumes that the current position (longitude, latitude, and altitude) is accurate. It uses an averaged solution of the time information from as many satellites as the receiver is tracking, up to eight.

For additional information on the “STATIONARY” mode, Chapter Five.

Choice “4>DYNAMIC” (Survey Mode)

Depressing the “4” keyboard switch selects the “DYNAMIC” mode and the “Operating Mode” changes to “Survey Mode” Pressing the MENU keyboard switch returns the display to the SET-UP MENU SCREEN.

This choice forces the GPS Receiver to remain in the position survey mode at all times.

When three satellites are in view, the unit will perform two-dimensional “position fixes” (latitude, and longitude). When four satellites are in view, the unit will perform three-dimensional “position fixes” (latitude, longitude, and altitude).

For additional information on the “DYNAMIC” mode, see Chapter Five.

Choice “5>FW” (Flywheel Mode)

Depressing the “5” keyboard switch selects the “FLYWHEEL” mode and the “Operating Mode” changes to “FLYWHEEL.” Pressing the MENU keyboard switch returns the display to the SET-UP MENU SCREEN.

CHAPTER THREE

This choice forces the TC&FG into the Flywheel (time code generator) mode. In this mode the unit does *not* get synchronization from the GPS RPU (Receiver Processor Unit). The internal oscillator is *not* disciplined. The antenna may or may not be connected. No error messages are displayed or generated via the RS-232 I/O. To set generated time, refer to “SET TIME (TIME SELECTION).

B. 2> SET TIME (SET TIME SELECTION)

Pressing the #2 keyboard switch selects the “SET TIME.” The display will switch to that shown on the following page.

Setting the time is only applicable if the unit is not actively tracking one or more satellites.

ENTER TIME XXX XX:XX:XX

If it is desired to set “TIME” and use the GPS system as a time code generator for any number of reasons such as a faulty antenna, the desired “TIME” may be entered using the numeric keys of the keyboard. Three digits must be entered for the day-of-year, two digits for the hour, two digits for the minute and two digits for the seconds. Leading “zeroes” are required if necessary.

The GPS receiver will use this “TIME” input as its time until the time is acquired from a GPS satellite. The 1pps output of the GPS receiver will not be on time with UTC or GPS, whichever has been selected, until the GPS receiver has acquired time from the satellites.

If the optional “Preset Year” feature is installed, a “Preset Year” message will be displayed when you have finished entering the time of year, or by pressing the MENU keyboard switch. The following message will appear which will enable year preset:

ENTER YEAR XX
ENTER TIME XXX XX:XX:XX

Note: If the user enters a two-digit number between 91 and 99, the year is assumed to be 1991 to 1999. If the user enters a two-digit number between 00 and 90, the year is assumed to be 2000 to 2090.

Pressing the menu key of the keyboard while the “SET TIME” display is selected leads to a sub menu display as follows:

1>SYNC XXX

XXX is UTC or GPS

When this display is shown pressing the “1” key of the keyboard causes “SYNC” to toggle between UTC and GPS.

C. 3> SET POSITION (ENTER POSITION SELECTED)

Pressing the “3” keyboard switch selects “3>SET POSITION” which allows the user to enter an accurate position comprised of latitude and longitude in degrees, and minutes to the nearest thousandth of a minute, the Hemisphere (North, South, East, or West) and the altitude in meters referred to WGS-84. This causes the display to change to that shown on the following page:

ENTER LATITUDE: XX XX:XXX

Using the numeric keys of the keyboard enter the latitude in degrees and minutes to the thousandth of a minute and the display will change to that shown below:

ENTER 1 = NORTH, 2 = SOUTH

Using the numeric keys of the keyboard enter either a “1” for the Northern Hemisphere, or a “2” for the Southern Hemisphere and the display will change to that shown below:

ENTER LONGITUDE: XXX.XX.XXX

Using the numeric keys of the keyboard, enter the longitude in degrees and minutes to the thousandth of a minute, and the display will change to that shown below:

ENTER 1 = EAST, 2 = WEST

Using the numeric keys of the keyboard enter either a “1” for the Eastern Hemisphere or a “2” for the Western Hemisphere and the display will change to that shown below:

ENTER ALTITUDE: XXXX METERS

Using the numeric keys of the keyboard, enter a four digit WGS-84 altitude in meters and the display will change to that shown below:

ENTER 1 = POS, 2 = NEG

Using the numeric keys of the keyboard, enter either a “1” for a positive altitude, or a “2” for a negative altitude, for above or below the GPS Reference Sphere (WGS-84).

Note: If a mistake has been made while entering this data, press the MENU keyboard switch to exit, then return to this selection and reenter the data.

D. 4> SNR (SIGNAL NOISE DENSITY RATIO)

To request the signal SNR of the satellites currently being “tracked” by the receiver, press the “4” keyboard switch. The information may take up to ten seconds to be displayed. Each satellite number and its corresponding signal SNR will be displayed. The signal SNR is measured at antenna input. Typically it is a number between 30 to 55. (The larger the number, the better.)

Pressing the MENU key of the keyboard will return the display to the “MAIN MENU SCREEN.”

E. 5> OFFSET (LOCAL TIME OFFSET SELECTION)

Choice “5>” is the local time offset. This allows the user to input a desired time offset (in ½ hour increments) whereas the LCD, Optional LED display, and/or time output would be offset from the selected UTC or GPS time by the number of hours input. All offset entries are positive (0.00 to 23.5) and are calculated as west of the Greenwich Meridian.

The current offset will be displayed. Pressing the “5” keyboard switch will allow entry of the new offset.

Example:

California is eight hours later than GMT. The local time offset entry would be 08.0.

Japan is nine hours earlier than GMT. The local time offset entry would be 15.0.

The calculation for negative local time offsets (for example, nine hours earlier) is as follows:

(Offset) +24 = entry
(-9) +24 = 15

F. 6> SET DAC

Choice “6>” allows the user to enter a DAC (Digital to Analog Converter) value from 00000 to 65535. This value is a digital representation of the analog voltage (0 to +5 volts) that is used to control the internal oscillator. This feature is especially useful when attempting to null the oscillator (see Chapter Five).

When keyboard switch 6 is pressed, it allows the user to enter a five digit DAC value, the midrange being 32767.

3.3.4 RS-232 I/O CONFIGURATION MENU SCREEN

Subsequent pushing of the MENU keyboard switch will display the RS-232 Configuration Menu Screen which is shown below and contains the following choices:

		Column:								
		1	5	10	15	20	25	30	35	40
Row 1		RS232	IO:<1>	9600<2>	ODD<3>	8	BITS/1	STOP		
Row 2		5>CABLE	DLY:0050'	<6>1344:	ON	<7>	TI:	OFF		

This screen allows front panel keyboard selection of the RS-232 I/O parameters and the antenna cable delay.

Use the “1” keyboard switch to select the BAUD RATE. Keep pressing the “1” keyboard switch until the desired baud rate appears. The choices are as follows:

50, 300, 600, 1200, 2400, 4800, 9600, 19200

Use the “2” keyboard switch to select the PARITY. Keep pressing the “2” keyboard switch until the desired parity appears. The choices are as follows:

NONE, ODD, and EVEN

Use the “3” keyboard switch to select the desired number of data bits (word length). Keep pressing the “3” keyboard switch to cycle through the choices which are 7 DATA BITS, and 1 STOP BIT, or 8 DATA BITS and 1 STOP BIT.

The antenna cable length can be entered by pressing the “5” keyboard switch and entering four digits in feet which corresponds to the length of the antenna cable. This will make the 1pps output on time by compensating for the propagation delay of the cable.

The “6” keyboard switch allows the user to generate either a modified IRIG B per IEEE Std. 1344 (ON) or the standard IRIG B (OFF) with zeros in the control function area. It is an alternate action switch. For the format of IEEE Std. 1344, see Chapter One.

The “7” keyboard switch allows the user to enable or disable time interval measurement, and to select the rising or falling edge of the input pulse as the start (trigger) of this measurement.

Sequentially pushing the switch produces the following:

- Off
- On 1 (selecting the rising edge as the on-time point)
- Off
- On 0 (selecting the falling edge as the on-time point)

CHAPTER THREE

3.3.5 MULTIPLE TIME CODE OUTPUTS MENU SCREEN (MODELS ET6000 and ET6010 only)

If the MENU keyboard switch is pushed again, the LCD will display the Multiple Time Code Outputs Menu Screen which is shown on below. Although this screen is displayed, it is only applicable if the TC&FG is configured and furnished with the Multiple Time Code Outputs option, GPS Opt 01 (Assembly 55116).

Column:

	1	5	10	15	20	25	30	35	40
Row 1	CODE SELECT:								
Row 2	1> CODE-1 2> CODE-2 3> CODE-3								

If this option is provided, its Option Description will be located in Appendix C of this manual.

3.3.6 PRESET COINCIDENCE MENU SCREEN (MODEL ET6500 ONLY)

Subsequent pushing of the MENU keyboard switch will display the Preset Coincidence Menu Screen which will look similar to the following:

Column:

	1	5	10	15	20	25	30	35	40
Row 1	COINCIDENCE: D H M S mS uS nS								
Row 2	TIME : XXX XX:XX:XX.XXX XXX X00								

This feature provides the ability to preset a coincidence time into the GPS TC & FG from hundreds of days through tenths of microseconds. When the coincidence time equals the GPS time, a 2 microsecond positive going pulse is output. This coincidence output is on rear panel BNC J7 (Refer to Chapter One)

NOTE: Preset coincidence time should not be entered until the unit is actively tracking satellites and the LOCK LED is illuminated.

Also, the preset coincidence time has to be at least 2 seconds greater than the GPS time.

Enter the preset coincidence time using the numbered keypads 0-9 starting with hundreds of days. If an error is made while entering the time, finish entering the time, cycle back through the menus and then reenter the time.

CHAPTER THREE

The actual external frequency measurement number itself is also auto scaled. It will display measurements in parts to E-09, E-12, or E-14. If the input offset/measurement is greater than 1×10^{-5} or if the input signal contains noise, "TOO HIGH" will be displayed.

The external frequency input is divided down to 1pps, and then compared against the unit's internal 1PPS. It is important to enter the correct frequency number or it will cause a large error in the final result.

The measurement number is a relative frequency error between the unit and the external frequency source. If the unit's frequency is lower than the frequency of the external source, a negative number is displayed. If the unit's frequency is higher than the frequency of the external source, a positive number is displayed.

3.3.8 SINGLE EVENT LOG MENU SCREEN

Subsequent pushing of the MENU keyboard switch will display the Single Event Log Menu Screen which is shown below and contains these choices:

Column:

	1	5	10	15	20	25	30	35	40
Row 1	EVENT LOG<1>STOP<2>CLR<3>EDGE000<4>START								
Row 2	S00 E000 ?			<5>← <6>→					

Single Event Log is operational in the AUTO, DYNAMIC, and STATIONARY modes when "LOCKED" with the following qualification: If after achieving "LOCKED" the unit loses satellites and the "TRACKING" and "LOCKED" LEDs go out, this function will still be operational until satellites are reacquired. At that point, it won't be operational again until "LOCKED" has been achieved. This function is always available in "FLYWHEEL" mode.

The event log can also be programmed, read, and/or cleared, using the front panel keyboard.

Pushing keyboard switch "1" stops the event log.

Pushing keyboard switch "2" clears the event log.

Pushing keyboard switch "3" selects which edge of the event input pulse to trigger on. (0 = falling edge, 1 = rising edge). The first digit is for Channel Three and the second digit is for Channel Two (neither of which are active in this option). The third digit is for Channel One. Keep pushing keyboard switch "3" until the correct number (either one or zero) appears in the third digit. The one or zero appearing in the first and second digits is ignored in this option, therefore the contents of these digits will not be important to the unit.

Pushing keyboard switch "4" starts the events log.

Pushing keyboard switch “5” will send you to the previous event.

Pushing keyboard switch “6” will send you to the next event.

The second line of the LCD displays the status, event number, and the time of the event.

EXAMPLE

Note: The number enclosed in the arrows indicates the keyboard number.
 (<1> = keyboard switch number one.)

```
EVENT LOG<1>STOP<2>CLR<3>EDGE100<4>START
S00*E010 1 165,21:16:04,3267548<5> <6>
```

- 100 = Rising edge on channel three, falling edge on channels two and one.
- S00 = Event status NORMAL
- * = Event Log ENABLED. A blank means the event log has been DISABLED.
- E010 = Event Number Ten
- 1 = Channel Number One
- 165 = Day-of-Year
- 21 = Hours
- 16 = Minutes
- 04 = Seconds
- 3267548 = Subseconds (tenths of seconds through hundreds-of-nanoseconds).

3.3.9 50/60HZ MEASUREMENT MENU SCREEN (MODEL ET6500 ONLY)

The 50/60Hz measurement features can be programmed using the front panel keypad switches. Cycle through the various menus on the LCD display, using the MENU switch, until the 50/60Hz Measurement screen appears. It will look similar to the following:

	1	5	10	15	20	25	30	35	40
Row 1	FRQ: 60.0001HZ		PHASE: 123.4°			ERR: -00.4315S			
Row 2	1>OFFSET: +00.0005		<4>OFF		<5>ON		<6>60HZ/OFF		

50/60Hz Measurement is operational in the AUTO, DYNAMIC, and STATIONARY modes when “LOCKED” with the following qualification: If after achieving “LOCKED” the unit loses satellites and the “TRACKING” and “LOCKED” LEDs go out, this function will still be operational until satellites are reacquired. At that point, it won’t be operational again until “LOCKED” has been achieved. This function is always available in “FLYWHEEL” mode.

Operation of the 50/60Hz measurement feature is as follows:

CHAPTER THREE

With the unit operating, connect the AC source to be measured to TB1-8 and TB1-9 (50/60Hz Measurement Input). Make sure that when plugging in the cable to the AC power source that it is correctly polarized. For example, the pin labeled AC HI (50/60Hz Measurement Input - HI) is plugged into the AC HOT receptacle. If this connection is reversed, the phase angle measurement will be off by 180°.

The frequency measurement is made by counting the number of 50/60Hz sine waves occurring between successive corrected 1pps pulses from the GPS receiver.

The phase angle measurement is made by calculating where the 1pps pulse occurs in relationship to the 50/60Hz sine wave.

The error calculation is the accumulated time error based on whether the sine wave is fast or slow. A time error offset can be entered when the 50/60Hz measurement is OFF, which is used as a starting point for the error calculation.

Pushing keypad switch number one will program the offset. Note that an offset cannot be entered until the measurement is stopped. OFF will appear in the lower right hand corner of the LCD display. If the unit is not locked, ERR will appear. If the measurement is started, ON will appear. Keypad switch number two will select “+” (plus) and switch number three will select “-” (minus). The number of seconds offset can then be entered using the keypad switches up to 99.999 seconds.

Pushing the number four key will stop the measurement, and OFF will appear on the LCD display in the lower right-hand corner.

Pushing the number five key will start the measurement, and ON will appear in the lower right-hand corner of the LCD display. If the unit is not locked, ERR will appear in the lower right hand corner of the LCD display.

Pushing the number six key of the keypad selects either 50Hz or 60Hz. 50Hz or 60Hz selection can only be done when the unit is not doing measurements. OFF is displayed in the lower right hand corner of the LCD display.

3.3.10 AUTO DAYLIGHT SAVINGS MENU SCREEN

Subsequent pushing of the MENU keyboard switch will display the Auto Daylight Savings Menu Screen which is shown below and contains this choice:

		Column:								
		1	5	10	15	20	25	30	35	40
Row 1		AUTO DAYLIGHT SAVING <1> OFF								
Row 2										

Pushing the “1” keyboard switch will alternately enable or disable the Auto Daylight Savings Time feature. It can also be programmed to automatically turn on/off for up to ten years using the RS-232 I/O port. Refer to Chapter Four of this manual.

3.3.11 MUX OUTPUT MENU SCREEN

Subsequent pushing of the MENU keyboard switch will display the Mux Output Menu Screen which is shown below and contains these choices:

		Column:								
		1	5	10	15	20	25	30	35	40
Row 1		MUX OUT <1>CH: 1 <2>OUTPUT:DC CODE								
Row 2		<3, 5>KEYLOCK: OFF								

The rear panel BNC connectors (J4 through J9) can be configured to output various timing signals using the internal jumper pins and the front panel keyboard.

If the MUX input to any output buffer is jumper selected, one of sixteen inputs to that multiplexer can be selected via the front panel keyboard.

This menu screen allows selection of the outputs on the rear panel BNC connectors J4 through J9.

Pushing the “1” front panel keyboard switch cycles through the output channels (1-4).

Channel One controls MUX outputs on J4 and J9.

Channel Two controls MUX outputs on J5 and J8.

Channel Three controls MUX outputs on J6.

CHAPTER THREE

Channel Four controls MUX outputs on J7.

Pushing the “2” front panel keyboard switch cycles through the outputs available for the respective channel selected.

The choices are as follows (see the paragraph entitled “Optional Pulse Rate Outputs” in Chapter One):

10MHz	100Hz	LOCKED
5MHz	10Hz/1PPH*	+5 VOLTS
1MHz	1Hz	1PPS
100KHz	.1Hz	DC CODE
10KHz/2PPH*	1PPM	
1KHz	TRACKING	

1PPS is a 30-50uS wide pulse, positive edge on-time.

Tracking output is a TTL low when not tracking and a TTL high when tracking.

Locked output is a TTL low when not locked and a TTL high when locked.

* Models ET6000 and ET6010 output 10KHz and 10Hz. Model ET6500 outputs 2PPS and 1PPH.

Note: The MUX outputs can also be read and selected via the RS-232 I/O port. See paragraphs titled “Request MUX Output” and “Set MUX Output” in Chapter Four of this User’s Guide.

The standard configuration is as follows:

- J4 - TRACKING (TTL)
- J5 - LOCKED (TTL)
- J6 - 1PPS
- J7 - 10MHz SINE WAVE
- J8 - IRIG B (AC)
- J9 - IRIG B (DC)
- J10 - 1PPS INPUT (Time Interval Measurement)

Configurations other than the above standard will be found in the GPS Option/Connector Configuration Sheet included in this User’s Guide.

The internal jumper pins are shown in Figure 2-3 in Chapter Two.

Jumpers J14 and J24 are associated with BNC J4. Jumpers J15 and J25 are associated with BNC J5, etc. The basic circuitry is explained in the following example:

- Jumpering J24 pins 1 and 2 connects the output of a buffer to J4.
- J14 selects the input to that buffer. J14 pins 2, 4, 6, and 8 are connected in common to the buffer input.
- J14 pins 1, 3, 5, and 7 select various inputs to that buffer as shown in Figure 2-3 in Chapter Two.
- The MUX input (jumpering pins J14 1 and 2) selects a 16:1 software controlled multiplexer, the output of which is selectable using the front panel keyboard switches (or via the RS-232 I/O).
- The output buffer can also be used to provide a relay closure on J4. The relay closure will either be an open or closure to ground. To enable this configuration, jumper J24 pins 1 and 3, and J24 pins 2 and 4.

- BNC's J6 and J7 don't have the optional relay configuration.
-

If the MUX input to any output buffer is jumper selected, one of the sixteen inputs to that multiplexer can be selected by the front panel keyboard.

Pushing the "3" followed by "5" front panel keyboard allows the user to enable or disable operation of the front panel keyboard. The default condition for Keyboard Lock is OFF. This means that the keyboard functions normally. If the user wishes to activate Keyboard Lock, push the "3" followed by "5" keyboard switch.

When Keyboard Lock is ON, only the MENU key will function. Nothing can be entered or changed from the front panel. If the user wishes to turn OFF Keyboard Lock, cycle through the various menus until the Mux Output Menu Screen appears. Push the "3" followed by "5" keyboard switch and XXXX will appear on the screen. Enter 9975 and Keyboard Lock will turn to OFF.

3.3.12 PRINTER PORT CONFIGURATION MENU SCREEN

Subsequent pushing of the MENU keyboard switch will display the Printer Port Configuration Menu Screen, which is shown below and contains these choices:

		Column:								
		1	5	10	15	20	25	30	35	40
Row 1	PRINTER	:<1>	9600	<2>	NONE	<3>	8BIT	<4>	1	STP
Row 2		<5>	STANDARD MODE							

CHAPTER THREE

This screen allows front panel keyboard selection of the Printer Output port parameters.

Use the “1” keyboard switch to select the BAUD RATE. Keep pressing the “1” keyboard switch until the desired baud rate appears. The choices are as follows:

50, 300, 600, 1200, 2400, 4800, 9600, 19200

Use the “2” keyboard switch to select the PARITY. Keep pressing the “2” keyboard switch until the desired parity appears. The choices are as follows:

NONE, ODD, and EVEN

Use the “3” keyboard switch to select the desired number of data bits (word length). The choices are 7 or 8 data bits.

Use keyboard switch “4” to select the number of stop bits (1 or 2).

Use keyboard switch “5” to select the printer output format, either “Standard” or “One Second Burst”.

Standard RS232 Printer Output

This printer port provides the ability to output time, mode, status, frequency, position, and other optional data to an RS-232 compatible serial printer or terminal.

For the J11 connector pin assignments, refer to Chapter One.

The following are examples of output data:

```
94 027.17:04:38 M0 S00 E00 25 00 00 00 -0019-E12 33 48.8270N 117 53.3864W +0028 T1
705337.516
```

```
94 027.17:04:43 M0 S00 E00 25 00 00 00 -0019-E12 33 48.8270N 117 53.3864W +0028 T1
705337.516
```

```
94 027.17:04:48 M0 S00 E00 25 00 00 00 -0019-E12 33 48.8270N 117 53.3864W +0028 T1
705337.516
```

94 = year

027.17:04:38 = time (days, hours, minutes, seconds)

M0 - mode (start-up mode)

* S00 = status code (doing GPS corrections)

* E00 = error code (system check OK)

25 00 00 00 = tracking satellite vehicle 25

-0019E-12- frequency offset measured in parts to 10^{-12}
 33 48.8270N = latitude 33 degrees 48.8270 minutes, north
 117 53.3864W - longitude 117 degrees 53.3864 minutes, west
 +0028 = altitude in meters
 T1 705337.516 = time interval in microseconds

* For a listing of status codes and error codes, see Chapter Four of this User's Guide.

External frequency measurement can be substituted for time interval if available and previously enabled. **One Second Burst (RS232 ASCII Time Burst Mode Output)**

This interface is configured as Data Terminal Equipment (DTE), synchronous 1PPS "Burst" mode, using 9600 Baud. No control/handshake lines are utilized. The time word output is shown below in Table 1. Each byte consists of one start bit, eight data bits, one parity bit (odd) and one stop bit. However, this configuration can be changed using the front panel keyboard switches or remotely using the RS-232 I/O.

The data transmission is serial asynchronous by character, and the ASCII character code is used. The time information is interpreted as being UTC time.

(SOH) DDD:HH:MM:SSQ (CR) (LF)

See Table 1 for the definition of each field contained in this time information string.

Table 1
Protocol 1
Time Information

Field	Definition
(SOH)	Start of Header (ASCII control character).
DDD	Day of Year.
HH	Hours (24-hour clock).
MM	Minutes.
SS	Seconds.
Q	Quality indicator (see description below).
(CR)	Carriage Return (ASCII control character).
(LF)	Line Feed (ASCII control character).

The on-time point is at the beginning of the Carriage Return character.

Quality Indicator:

This indicator is an estimation of the accuracy of the unit's 1PPS compared to the GPS system 1PPS.

CHAPTER THREE

ASCII Character	HEX Equivalent	Definition
(space)	20	< 1 microsecond
.	2E	< 10 microseconds
*	2A	< 100 microseconds
#	23	< 1 millisecond
?	3F	> 1 millisecond (unknown)

3.3.13 IEEE-488 I/O INTERFACE MENU SCREEN (MODELS ET6000 AND ET6010 ONLY)

If the keyboard switch is pushed again, the LCD will display the IEEE-488 I/O Interface Menu Screen, which is shown below. Although this screen is displayed, it is only applicable if the TC&FG is configured and furnished with the IEEE-488 I/O Interface option, GPS Opt 14 (Assembly 55115).

Column:

	1	5	10	15	20	25	30	35	40
Row 1	<1> IEEE488 ADDR.17								
Row 2									

If this option is provided, its Option Description will be located in Appendix C of this manual.

3.4 CONFIGURATION OF REAR PANEL BNC CONNECTORS J4-J9

The rear panel BNC connectors (J4 through J9) can be configured to output various timing signals using the internal jumper pins and the front panel keyboard.

Per Figure 2-3 in Chapter Two, the following table details the various outputs available at J4:

JUMPER BLOCK J24	JUMPER BLOCK J14	OUTPUT AT J4
pins 1 and 2 shorted	pins 1 and 2 shorted	1 of 16 selectable Channel 1 Mux outputs
pins 1 and 2 shorted	pins 3 and 4 shorted	IRIG B AC code out
pins 1 and 2 shorted	pins 5 and 6 shorted	10MHz sine wave output
pins 1 and 2 shorted	pins 7 and 8 shorted	Tracking TTL output
pins 1 and 3 shorted	pins 2 and 4 shorted	Tracking (relay closure to ground)

Per Figure 2-3 in Chapter Two, the following table details the various outputs available at J5:

JUMPER BLOCK J25	JUMPER BLOCK J15	OUTPUT AT J5
pins 1 and 2 shorted	pins 1 and 2 shorted	1 of 16 selectable Channel 2 Mux outputs
pins 1 and 2 shorted	pins 3 and 4 shorted	IRIG B AC code out
pins 1 and 2 shorted	pins 5 and 6 shorted	10MHz sine wave output
pins 1 and 2 shorted	pins 7 and 8 shorted	Locked TTL output
pins 1 and 3 shorted	pins 2 and 4 shorted	Locked (relay closure to ground)

Per Figure 2-3 in Chapter Two, the following table details the various outputs available at J6:

JUMPER BLOCK J16	OUTPUT AT J6
pins 1 and 2 shorted	1 of 16 selectable Channel 3 Mux outputs
pins 3 and 4 shorted	IRIG B AC code out
pins 5 and 6 shorted	10MHz sine wave output
pins 7 and 8 shorted	unused

Per Figure 2-3 in Chapter Two, the following table details the various outputs available at J7:

JUMPER BLOCK J17	OUTPUT AT J7
pins 1 and 2 shorted	1 of 16 selectable Channel 4 Mux outputs
pins 3 and 4 shorted	IRIG B AC code out
pins 5 and 6 shorted	10MHz sine wave output
pins 7 and 8 shorted	unused

Per Figure 2-3 in Chapter Two, the following table details the various outputs available at J8:

JUMPER BLOCK J28	JUMPER BLOCK J18	OUTPUT AT J8
pins 1 and 2 shorted	pins 1 and 2 shorted	1 of 16 selectable Channel 2 Mux outputs
pins 1 and 2 shorted	pins 3 and 4 shorted	IRIG B AC code out
pins 1 and 2 shorted	pins 5 and 6 shorted	10MHz sine wave output
pins 1 and 2 shorted	pins 7 and 8 shorted	unused
pins 3 and 4 shorted	N/A	Event 3 <u>input</u>

Per Figure 2-3 in Chapter Two, the following table details the various outputs available at J9:

JUMPER BLOCK J29	JUMPER BLOCK J19	OUTPUT AT J9
pins 1 and 2 shorted	pins 1 and 2 shorted	1 of 16 selectable Channel 1 Mux outputs
pins 1 and 2 shorted	pins 3 and 4 shorted	IRIG B AC code out
pins 1 and 2 shorted	pins 5 and 6 shorted	10MHz sine wave output
pins 1 and 2 shorted	pins 7 and 8 shorted	unused
pins 3 and 4 shorted	N/A	Event 2 <u>input</u>

This Page Intentionally Left Blank

CHAPTER FOUR

I/O PORT DATA INPUT/OUTPUT

4.0 INTRODUCTION

The GPS timing unit has been equipped with an RS-232 interface using a nine pin connector designated as RS-232 I/O J12. It can be used to communicate to and from the GPS ExacTime unit. All communication is in the ASCII format. The standard character protocol is one start bit, eight data bits, an odd parity bit, and one stop bit. However, the baud rate, number of data bits, parity, and number of stop bits are selectable using the front panel keyboard switches. See Chapter Three, “Additional Menu Screens.”

The interface cable pin assignments and designations are shown in Chapter Two.

All communication to the GPS ExacTime Unit consists of two or three categories of characters. The first category is a single character, which is always an ASCII \$ (Hex 24). This is the attention/log-on character. The second category is an ID ASCII character, which is a command to the GPS ExacTime Unit. The third category (which may or may not be applicable) is a series of ASCII data bits to input data into the GPS ExacTime Unit. Leading zeros must be used where necessary. For example, if the number is fifty-two, and if the data to be entered is a four digit number, then it must be entered as 0052.

Note: If a mistake is made while inputting new characters (prior to the last character), issuing the “\$” character, this will cause a reset, and the new (correct) characters can be input.

When entering data via the RS-232 I/O port, if there is a pause longer than three seconds between input values, communication with the GPS timing unit will terminate.

Table 4-1 shows the command options available. The ASCII character is shown following its HEX equivalent. Following the table, each command is described with the necessary steps for execution.

Table 4-1 is located on the following page.

Table 4-1
RS-232 ASCII I/O Command Table

ASCII ID Character	HEX Character	Description
`	60	Symmetricon Firmware Version.
c	63	UTC Sync.
d	64	GPS Sync.
e	65	Print Frequency Offset.
f	66	Print Time, Status, Error Code, and SV Number.
=	3D	Print Year (4 digits), Time, Status, Error Code and SV Number.
i	69	Print Position.
j	6A	Clear Event Data.
k	6B	Print Event Data.
p	70	Request One Event Log Data.
l	6C	Enable Event Log.
m	6D	Disable Event Log.
r	72	Select Mode.
s	73	Enable Time Interval.
t	74	Disable Time Interval.
u	75	Request Time Interval.
x	78	Request Elevation Mask Angle.
y	79	Enter Elevation Mask Angle.
z	7A	Enable Discipline.
{	7B	Disable Discipline.
}	7D	Enter Position.
~	7E	Enter DAC Value.
N	4E	Request DAC Value.
Q	51	Enter Number of Position Averages.
	7C	Enter Local Time Offset.
T	54	Enter Cable Delay.
U	55	Request Cable Delay.
W	57	Re-synchronize Minor Time.
X	58	Select Default Values.
Y	59	*External Frequency Measurement – Select Input Frequency
Z	5A	*External Frequency Measurement – Enable/Disable
[5B	*External Frequency Measurement – Request Data

* Models ET6000 and ET6010 only.

The remainder of Table 4-1 is continued on the following page.

Table 4-1
RS-232 ASCII I/O Command Table, Continued...

ASCII ID Character	HEX Character	Description
]]	5D	Request Satellite SNR.
^	5E	Request Unit Operating Parameters.
B	42	Enable/Disable 50/60Hz Measurement (Model 6500 only).
L	4C	50/60Hz Selection (Model 6500 only).
D	44	Enter 50/60Hz Offset Data (Model 6500 only)
A	41	Request 50/60Hz Measurement Data (Model 6500 only).
C	43	**Enter IEEE-488 Address. (Models 6000 and 6010 only)
H	48	Printer – Set-Up Configuration.
I	49	Printer – Request Configuration.
>	3E	Printer port Mode selection.
g	67	Printer – Select Output Rate.
h	68	Printer – Request Output Rate.
n	6E	Printer – Enable/Disable & Data Select.
o	6F	Enter Preset Coincidence Time (Model 6500 only).
JR	4A, 52	Request MUX output.
JS	4A, 53	Set MUX output.
K	4B	Set Major Time.
<	3C	Set Year.
OD	4F, 44	Disable Auto Daylight Savings Time Function.
OE	4F, 45	Enable Auto Daylight Savings Time Function.
OF	4F, 46	Set Auto Daylight Savings Time Default Interval.
OR	4F, 52	Request Auto Daylight Savings Time Interval.
OS	4F, 53	Set Auto Daylight Savings Time Interval.
E	45	** Set-Up Three Channel Encoder (Models 6000 and 6010 only).
@	40	Request Unit Serial Number

** Optional. Refer to the Option Description in Appendix C.

4.1 SYMMETRICOM FIRMWARE VERSION

This command outputs the Symmetricom firmware version installed in the unit.

- The user inputs \$` (HEX 24/HEX 60).
- The unit will respond with eight characters followed by CR/LF.

CHAPTER FOUR

4.2 UTC SYNC

This command will synchronize the unit to the Universal Time Coordinated time standard.

- The user inputs \$c (HEX 24/HEX 63).
- The unit will respond with OK, followed by CR/LF.

4.3 GPS SYNC

This command will synchronize the unit to the Global Positioning System time standard.

- The user inputs \$d (HEX 24/HEX 64).
- The unit will respond with OK, followed by CR/LF.

4.4 PRINT FREQUENCY OFFSET

This command will output the calculated difference between the units' local time base and the GPS system frequency.

- The user inputs \$e (HEX 24/HEX 65).
- The unit will respond with a plus or minus sign, four digits, and an exponent having the weight of parts in 10^{-9} or 10^{-12} .

Example: +0579E-09

4.5 PRINT TIME, STATUS, ERROR CODE, AND SATELLITE VEHICLE NUMBERS

This command allows the user to print the year, day-of-year, hour, minute, second, millisecond, status code, error code, and the vehicle numbers of the satellites being tracked. The Status Codes are shown in Table 4-2 and the Error Codes are shown in Table 4-3.

Table 4-2
Status Codes

Characters	Definition
S00	Doing GPS Correction.
S01	GPS time not acquired.
S02	Waiting for almanac.
S05	Unit stabilizing.

Table 4-2 continued on next page.

Characters	Definition
S08	No useable satellites.
S14	Oscillator stabilizing.
S15	Position Survey
S16	Flywheel Mode

Note: If a Status Code is produced other than those listed above, the error is undefined.

**Table 4-3
Error Codes**

Characters	Definition
E00	System check OK.
E02	Processor error.
E04	Ant. Undercurrent
E08	Ant. Overcurrent

- If the user inputs \$f (HEX 24/HEX 66).
- The unit will respond with the following:
 - 3 digits of day of year.
 - 2 digits of hour.
 - 2 digits of minute.
 - 2 digits of second.
 - 3 digits of milliseconds (space).
 - 3 character status code (space).
 - 3 character error code (space).
 - Up to 4 satellite vehicle numbers CR/LF.

Each satellite vehicle is identified by its PRN I.D.

Example: 056.12:13:45.768 S00 E00 03 13 20 26

It is the 56th day of the year (February 25th).
 The time is 12 hours, 13 minutes, 45 seconds and 768 milliseconds.
 The unit is doing GPS corrections.
 The system check is OK.
 The unit is tracking satellites 3, 13, 20, and 26.

- If the user inputs \$ = (HEX 24/HEX 3D).

CHAPTER FOUR

The unit will respond with the following:

- 4 digits of year.
- 3 digits of day of year.
- 2 digits of hour.
- 2 digits of minute.
- 2 digits of second.
- 3 digits of milliseconds (space).
- 3 character status code (space).
- 3 character error code (space).
- Up to 4 satellite vehicle numbers CR/LF.

Each satellite vehicle is identified by its PRN I.D.

Example: 1999 056.12:13:45.768 S00 E00 03 13 20 26

Year = 1999

It is the 56th day of the year (February 25th).

The time is 12 hours, 13 minutes, 45 seconds and 768 milliseconds.

The unit is doing GPS corrections.

The system check is OK.

The unit is tracking satellites 3, 13, 20, and 26.

4.6 PRINT POSITION

This command allows the user to read the accurate position known to the GPS ExacTime unit. The latitude will be expressed in units of degrees and minutes labeled North or South, relative to the equatorial plane which is defined as zero latitude. The longitude will be expressed in units of degrees and minutes labeled East or West relative to the Greenwich Meridian. The altitude will be expressed in meters either above (+) or below (-) the GPS Reference Sphere (WGS-84). Altitude can be negative, and a sea level altitude may be above or below the GPS Reference Sphere.

- The user inputs \$i (HEX 24/HEX 69).
- The unit will respond with the following:
 - 2 digits of degrees latitude (space).
 - 2 digits of minutes latitude.
 - 4 digits of ten thousandths of minutes latitude.
 - N or S (space).
 - 3 digits of degrees longitude (space).
 - 2 digits of minutes longitude.

4 digits of ten thousandths of minutes longitude.
 E or W (space).
 + or -.
 4 digits of altitude in meters CR/LF.

Example: 33 48.8241N 117 53.3970W +0026

4.7 CLEAR EVENT DATA

This command clears any previously stored events from memory, if the event option has been installed in the unit.

- The user inputs \$j (HEX 24/HEX 6A).
- The unit will respond with OK, followed by CR/LF.

4.8 PRINT EVENT DATA

The GPS Timing Unit has the optional capability of storing up to 256 events from up to three inputs (channels). When the command is sent to print the event data, the first response is three characters representing event status. The user responds with a % character. This is followed by the unit outputting the event number, the channel number, and the time the event occurred. When this first event has been output, the user must respond with a % character within three seconds signifying the event information has been taken. The unit will then output the second event.

This process of outputting the data followed by the user's response (%) continues until all events have been output. If the user does not take the data and respond with a % within three seconds, communication with the GPS timing unit will terminate. If no data is available, the unit will respond with a question mark. If more than 256 events occur, subsequent events will be lost or overwritten. If two events occur very close together, it is possible that one of the events could be missed. If that happens, the fact that an event has been missed will be reported in the event status. Table 4-4 shows the possible event status codes.

Table 4-4
Event Status Codes

Code	Definition
S00	Normal.
S02	Missed event Channel One.

CHAPTER FOUR

In the following example are the steps for printing (outputting) the single event log:

- The user inputs \$k (HEX 24/HEX 6B).
- The unit responds with S00 CR/LF.
- The user responds with %.
- The unit will then output the first event. E000 1 056.12:13:45.1437952 CR/LF.
-
- When this data has been taken, the user responds with %.
- The unit will output the second event. E001 1 056.12:13:46.5327642 CR/LF.
- When this data has been taken, the user responds with %.
- The unit will then output E002 ? CR/LF.

The question mark signifies that there is no data available. Event E001 was the last event.

In the above example, S00 indicates no missing events. The first event (E000) occurred on Channel One at the specified time. The second event (E001) occurred on Channel One at the specified time.

4.9 REQUEST ONE EVENT LOG DATA

This command allows the user to request data from any one of the 256 events.

- The user inputs \$p (HEX 24/HEX 70) followed by “aaa” where aaa is the three digit event number.
- The unit will respond with:

Sbb (space) Eaaa (space) xx (space) ddd.hh:mm:ss.cccccc CR/LF

Where:

- bb = event status
- aaa = requested event number
- xx = event channel number
- ddd = days
- hh = hours
- mm = minutes
- ss = seconds
- cc = subseconds

Example:

- User inputs \$p125
- Unit responds with S00 E125 01 056.12:13:45.1234567 CR/LF

The above example is event status 00, event number 125, event channel number 01, 56 days, 13 hours, 13 minutes, 45 seconds, and 123.4567 milliseconds.

4.10 ENABLE SINGLE EVENT LOG

This command enables the event log option. It consists of the log-on command followed by three digits. Entering “111” signifies that the positive/rising edge of the input pulse is the on-time edge of the event. Entering “000” signifies that the negative/falling edge of the input pulse is the on-time edge of the event.

When sent, this command automatically disables the 1pps time interval function.

- The user inputs \$1 (HEX 24/HEX 6C) and 3 digits.
- The unit will respond with OK, followed by CR/LF.

Example: 000

The above example will enable the single event log. The on-time edge of the input pulses will be the negative/falling edge.

4.11 DISABLE SINGLE EVENT LOG

This command disables the event data log.

- User inputs \$m (HEX 24/HEX 6D).
- The unit responds with OK CR/LF.

4.12 SELECT MODE

This command allows the user to select the mode of operation. This one digit command indicates the following modes:

- 0 = AUTO Mode.
- 1 = Stationary Mode (Timing Mode).
- 4 = Dynamic.
- 5 = Flywheel Mode.

CHAPTER FOUR

The user inputs \$r (HEX 24/HEX 72) 0.

- The unit responds with OK CR/LF.

The example above selects the AUTO mode of operation.

4.13 ENABLE TIME INTERVAL

This command enables the time interval measurement using the external 1pps input. The command must also indicate which edge of the 1pps input is going to be used.

0 = Negative/falling edge.

1 = Positive/rising edge.

This command automatically disables the event log feature.

- The user inputs \$s (HEX 24/HEX 73) 1.
- The unit responds with OK CR/LF.

The example above enables the time interval measurement feature and selects the positive edge of the 1pps input as the on-time edge.

4.14 DISABLE TIME INTERVAL

This command disables the time interval measurement.

- The user inputs \$t (HEX 24/HEX 74).
- The unit responds with OK CR/LF.

4.15 REQUEST TIME INTERVAL

This command allows the user to request the time interval measurement between the internal GPS corrected 1pps pulse and an external 1pps input pulse. The response consists of three digits of milliseconds, three digits of microseconds, and a decimal point followed by three digits of nanoseconds.

- The user inputs \$u (HEX 24/HEX 75).
- The unit responds with 134276.512 CR/LF.

The example above indicates that the difference between the internal GPS corrected 1pps pulse and the external 1pps pulse is 134276.512 microseconds.

Every time a measurement needs to be taken, a request has to be issued.

4.16 REQUEST ELEVATION MASK ANGLE

This command allows the user to view the currently selected mask angle.

The mask angle is the minimum angle (in degrees) for tracking satellites. The minimum angle is 0°.

- The user inputs \$x (HEX24/HEX78).
- The unit responds with 05 CR/LF.

The example above indicates an elevation mask angle of five degrees, which is the default.

4.17 ENTER ELEVATION MASK ANGLE

This command allows the user to input/change the mask angle.

- The user inputs \$y (HEX 24/HEX 79) 05.
- The unit responds with OK CR/LF.

The above example indicates that the user inputs an elevation angle mask of five degrees.

4.18 ENABLE DISCIPLINING

This command allows the user to enable the discipline feature. The internal time base is periodically disciplined/corrected to the GPS time base.

- The user inputs \$z (HEX 24/HEX 7A).
- The unit responds with OK CR/LF.

4.19 DISABLE DISCIPLINING

This command allows the user to disable the discipline feature.

- The user inputs \$ { (HEX 24/HEX 7B).

CHAPTER FOUR

- The unit responds with OK CR/LF.

4.20 ENTER POSITION

This command allows the user to manually enter the position of the antenna/preamp.

The command consists of :

Two digits of degrees latitude.
Two digits of minutes latitude.
Three digits of sub-minutes latitude.
N (North) or S (South).
Three digits of degrees longitude.
Two digits of minutes longitude.
Three digits of sub-minutes longitude.
E (East) or W (West).
+ (plus) or - (minus).
Four digits of altitude in meters.

-
- The user inputs \$ } (HEX 24/HEX 7D) 3348824N11753397W+0026
- The unit responds with OK CR/LF.

The above example is entering Symmetricom's position of:

Latitude 33° 48.824 N.
Longitude 117° 53.397 W.
Altitude + 0026 meters.

4.21 ENTER DAC VALUE

This command allows the user to manually enter a DAC (Digital to Analog Converter) value that is used to adjust the internal time base. This would typically be done prior to the front panel LOCKED LED turning on, if disciplining was turned off, or to null/calibrate the internal oscillator.

The DAC value consists of five digits from 00000 to 65535. If a number is entered that is greater than 65535, it will automatically be converted to 65535.

- The user inputs \$ ~ (HEX 24/HEX 7E) 32767.
- The unit responds with OK CR/LF.

The above example sets the DAC value at approximately the middle of its range.

4.22 REQUEST DAC VALUE

This command allows the user to request the current DAC value.

- The user inputs \$ N (HEX 24/HEX 4E).
- The unit responds with a five digit value followed by CR/LF.

4.23 ENTER NUMBER OF POSITION AVERAGES

This command allows the user to select the number of position averages that will be used to calculate position in the start-up mode of operation. The command is comprised of five digits representing a number from 00010 to 99999. Ten (0010) is the smallest number of position averages that can be entered. The default is 200.

- The user inputs \$Q (HEX 24/HEX 51) followed by four digits.
- The unit responds with OK CR/LF.

Note: The timing accuracy of this unit is directly related to the position accuracy. The more accurate the position, the more accurate the time. It is recommended that for timing accuracy of ≤ 300 nanoseconds, 2,000 to 5,000 position averages be performed to insure an accurate position or input an accurate, surveyed position into the unit.

4.24 ENTER LOCAL OFFSET

This command allows the user to input a desired time offset (in $\frac{1}{2}$ hour increments) whereas the LCD or optional LED display and/or time outputs would be offset from the selected UTC or GPS time by the number of hours input. All offsets entered (00.0 to 23.5) are positive and calculated as west of the Greenwich Meridian (or input an accurate, surveyed position into the unit).

- The user inputs \$| (HEX 24/HEX 7C) 07.0.
- The unit responds with OK CR/LF.

The above example (07.0) inputs a local time offset to correspond to daylight savings time in the Pacific Time Zone.

CHAPTER FOUR

4.25 ENTER CABLE DELAY

This command allows the user to enter a cable delay that compensates for the propagation delay between the antenna/preamp and the RPU caused by the cable. The delay is approximately 1.5 nanoseconds per foot of antenna cable. The user simply enters the total length of antenna cable as a four digit number expressed in feet.

- The user inputs \$T (HEX 24/HEX 54) 0100.
- The unit responds with OK CR/LF.

In the above example, the user has input cable delay to compensate for one-hundred feet of antenna cable.

4.26 REQUEST CABLE DELAY

This command allows the user to interrogate the GPS ExacTime unit and find out what cable delay the unit is currently using.

- The user inputs \$U (HEX 24/HEX 55).
- The unit responds with a four digit number that equates to the length of antenna cable (in feet) that is stored in memory, followed by CR/LF.

Note: This command would only be applicable if the user has changed antenna cable length and is unsure what delay has been programmed into the GPS ExacTime unit.

4.27 RESYNCHRONIZE MINOR TIME

This command allows the user to manually re-synchronize the minor time (subseconds) to the GPS on-time 1pps pulse. This command must be issued if the antenna cable length is changed and subsequently a new cable delay is entered.

- The user inputs \$W (HEX 24/HEX 57).
- The unit responds with OK CR/LF.

4.28 SELECT DEFAULT VALUES

This command allows the user to input/reset a series of default parameters into the GPS ExacTime Unit, which are:

Elevation Angle	5°
Mode	Start-up (AUTO).
Position Average Number	200
Time Interval	Disabled, falling edge.
Event Log	Disabled, falling edge (all three events).
Exact Frequency Measurement	Disabled.
Local Offset	00.0
Cable Delay	50
Position	Symmetricon's
MUX Outputs	CH1 IRIG B DC
	CH2 10MHz
	CH3 1pps
	CH4 10HMz

- The user inputs \$X (HEX 24/HEX 58).
- The unit responds with OK CR/LF.

4.29 EXTERNAL FREQUENCY MEASUREMENT – SELECT INPUT FREQUENCY

This command allows the user to specify the input frequency.

- User inputs \$Y (HEX 24/HEX 59) followed by eight digits and CR/LF. The eight (8) digits correspond to the input frequency. Leading zeros are required to be entered.
- The unit responds with OK CR/LF.

Example: \$Y01000000 CR/LF

The above example illustrates selecting an input frequency of 1MHz.

CHAPTER FOUR

4.30 EXTERNAL FREQUENCY MEASUREMENT – ENABLE/DISABLE

This command allows the user to enable the external frequency measurement option.

- The user inputs \$Z (HEX 24/HEX 5A) followed by a 1.
- The unit responds with OK CR/LF.

This command allows the user to disable the external frequency measurement option.

- The user inputs \$Z (HEX 24/HEX 5A) followed by a 0.
- The unit responds with OK CR/LF.

4.31 EXTERNAL FREQUENCY MEASUREMENT – REQUEST DATA

This command allows the user to request the external frequency measurement data. The measurement and subsequent calculation is done at least once every five seconds and is averaged over the time period beginning when the external frequency measurement option was enabled.

- The user inputs \$[(HEX 24/HEX 5B).
- The unit responds with a + or -, four digits representing the magnitude of drift/stability, E-, two digits (exponent - power of ten), space, four digits representing the time period in seconds, E+, two digits (exponent - power of ten).

4.32 REQUEST SATELLITE SIGNAL SNR

This command allows the user to obtain the signal SNR (Signal Noise Density Ratio) of each satellite in view. The larger the number, the greater the signal strength. Typical values are between 30 and 55.

- The user inputs \$] (HEX 24/HEX 5D).
- The unit responds with #, two digits of the satellite PRN number, and three digits of signal SNR. This format will be printed for each satellite in view.

If the signal SNR is 0.00, the satellite has not been acquired.

The last satellite's information will be followed by CR/LF.

Example: #12 +053 # 24 + 046 CR/LF

The above example illustrates the unit responding with a signal SNR of +53 for satellite vehicle twelve and +46 for satellite vehicle twenty-four. The actual message will contain more satellites than this example.

4.33 REQUEST UNIT OPERATING PARAMETERS

This command allows the user to request a number of operating parameters that aren't available with other specific commands.

- The user inputs \$^ (HEX 24/HEX 5E).
- The unit will respond with the following example:

U M0 D1 L00 LS13 PA0200 PR0 OS0 GPIB17 LK1

**Table 4-6
Operating Parameters**

U	UTC sync.
G	GPS sync.
M0	Mode 0 (Auto mode). 1 = Stationary, 2 = Dynamic, and 5 = Flywheel.
D1	Discipline. 1 = on, 0 = off.
L00	Local time offset.
LS13	Number (13) of Leap Seconds.
PA02000	Number of Position Averages.
PR0	Printer option. 0 = off, 1 = on.
OS0	External Oscillator. 0 = internal. 1 = external.
GPIB17	The address (17) of the IEEE-488 interface. This number will be meaningful only if the option is installed.
LK1	1 = Unit Locked 0 = Unit Unlocked

The last response is CR/LF.

CHAPTER FOUR

4.34 ENABLE/DISABLE 50/60Hz MEASUREMENT (MODEL ET6500 ONLY)

This command allows the user to enable or disable the 50/60Hz measurement feature.

- The user inputs \$B (HEX 24, HEX 42) followed by either a zero or a one. Zero turns the option OFF, and one turns the option ON.
- The unit responds with OK CR/LF.

Example: \$B1

The above example illustrates enabling the 50/60Hz measurement option.

If the unit is not locked, and it isn't available, the message "NOT LOCK" will be sent.

4.35 50/60Hz SELECTION (MODEL ET6500 ONLY)

This command allows the user to select either the 50Hz or 60Hz measurement features.

- The user inputs \$L (HEX 24, HEX 4C) followed by either a zero or a one. (Zero for 50Hz measurement, one for 60Hz measurement.) If the unit is not doing measurements, the RS-232 will respond with OK (CR) (LF), otherwise the unit will respond with ? (CR) (LF).

4.36 ENTER 50/60Hz OFFSET DATA (MODEL ET6500 ONLY)

This command allows the user to enter a starting point for the time error calculation.

- The user inputs \$D (HEX 24, HEX 44) followed by one digit (sign), two digits of seconds, a decimal point, followed by three digits of milliseconds. The sign digit's definition is 1 = + (plus) and 0 = - (minus).
- The unit responds OK CR/LF.

Example: \$D 023.406

The above example illustrates entering a time error offset of -20.346 seconds.

Note: The time error offset can only be entered if the 50/60Hz measurement option is OFF.

If a time offset is entered while the 50/60Hz option is enabled, the message “OPT ON” will be sent, and the time offset data is ignored.

The offset is stored in battery backed RAM, so it will be retained if the unit is turned OFF and then back ON again.

4.37 REQUEST 50/60Hz MEASUREMENT DATA (MODEL ET6500 ONLY)

This command allows the user to obtain the 50/60Hz measurement data.

- The user enters \$A (HEX 24, HEX 41).
- The unit responds with XX.XXXX, space, Hz (representing frequency measurement), space, ±XX.XXXX, space, SEC (representing accumulated time error), space, XXX.X space, DEG (representing phase angle measurement), space +XX.XXX, space, OFFSET (representing time offset), CR/LF.

Example: 60.1324 Hz + 01.357 SEC 180.2 DEG + 01.206 OFFSET CR/LF

The above response states that the frequency measurement is 60.1324Hz, and the accumulated time error is +1.3574 seconds.

The 60Hz measurement data is also available on the 50/60Hz measurement screen of the front panel LCD display. The format is as follows:

```
FRQ: 60.1324HZ PHASE: 180.2° ERROR: +01.3574S
1>OFFSET:+01.206S<4>OFF<5>ON<6>60HZ/ ON
```

If the 50/60Hz option is not enabled, ON will be replaced by OFF. When the unit is first turned on, it will come up in the OFF (default) mode. If the 50/60Hz option is turned on prior to the unit achieving LOCK, ON will be replaced by ERR and measurement data will not be available.

When measuring the 60Hz with a time period of 16.66 milliseconds, if a measurement occurs outside a one millisecond window of that time period (such as a noise spike), the measurement is ignored, and an error is counted. If 1,000 successive errors are read, the message ERR appears, and the 60Hz measurement option is turned OFF.

4.38 PRINTER – SET-UP CONFIGURATION

This command allows the user to set-up the printer configuration. It is applicable to both the Standard RS232 Printer Output and the One Second Burst RS232 ASCII Time Output.

CHAPTER FOUR

- The user enters \$H (HEX 24/HEX 48) followed by abcd where:

a = baud rate (0-7)

- 0 = 50
- 1 = 300
- 2 = 600
- 3 = 1200
- 4 = 2400
- 5 = 4800
- 6 = 9600
- 7 = 19200

b = number of data bits

- 0 = 7
- 1 = 8

c = parity

- 0 = none
- 1 = odd
- 2 = even

d = number of stop bits

- 0 = 1
- 1 = 2

4.39 PRINTER – REQUEST CONFIGURATION

This command allows the user to request the current printer set-up. It is applicable to both the Standard RS232 Printer Output and the One Second Burst RS232 ASCII Time Output.

- The user enters \$I (HEX 24/HEX 49).
- The unit responds with: 09600 8/7 N/O/E 1/2<CR><LF>. (Baud Rate) (8 or 7 data bits) (none, odd, or even parity) (1 or 2 stop bits) (carriage return) (line feed).

4.40 PRINTER PORT MODE SELECTION

This command allows the user to specify the printer mode or output format . The selection is either “Standard” or “One Second Burst”. For a detailed description of these two formats, refer to Chapter Three – Operation.

- The user inputs \$> (HEX 24/HEX 3E) followed by either a 0 or a 1.

The “0” is for the standard format.

The “1” is for the one second burst format.

- The unit responds with OK CR/LF.

4.41 PRINTER – SELECT OUTPUT RATE

This command allows the user to specify the interval rate at which the data is output. It can be any time from three (3) seconds to 9999 seconds. (Leading zeros are required). It is applicable only to the Standard RS232 Printer Output.

- User inputs \$g (HEX 24/HEX 67) followed by four (4) digits corresponding to the number of seconds.

Example: \$g0005

- The unit responds with OK CR/LF (carriage return/line feed).

Example: \$g0005

The above example illustrates selecting an output interval rate of five seconds.

4.42 PRINTER – REQUEST OUTPUT RATE

This command allows the user to determine what is the current output rate. It is applicable only to the Standard RS232 Printer Output.

- User inputs \$h(HEX 24/HEX 68).
- The unit responds with four (4) digits followed by CR/LF. These four digits correspond to the output interval rate in seconds.

4.43 PRINTER – ENABLE/DISABLE & DATA SELECT

This command is applicable only to the Standard RS232 Printer Output.

- User inputs \$n (HEX 24/HEX 6E) followed by three (3) digits.

CHAPTER FOUR

- The first digit enables or disables the printer port.

0 = printer port disabled

1 = printer port enabled

- The second digit enables or disables position information output.

0 = position information disabled

1 = position information enabled

- The third digit enables or disables the output of option data (if available).

0 = option data disabled

1 = option data enabled (if the option itself is available and has been previously turned on)

Example: \$n101

The unit responds with OK CR/LF.

The above example illustrates the user turning on the printer port, not outputting any position information, but outputting option data (such as external frequency measurement). Refer to the following examples of output data:

```
94 027.17:04:38 M0 S00 E00 25 00 00 00 -0019-E12 33 48.8270N 117 53.3864W +0028 T1
705337.512
```

```
94 027.17:04:43 M0 S00 E00 25 00 00 00 -0019-E12 33 48.8270N 117 53.3864W +0028 T1
705337.512
```

```
94 027.17:04:48 M0 S00 E00 25 00 00 00 -0019-E12 33 48.8270N 117 53.3864W +0028 T1
705337.512
```

94 = year
 027.17:04:38 = time (days, hours, minutes, seconds)
 M0 - mode (start-up mode)
 * S00 = status code (doing GPS corrections)
 * E00 = error code (system check OK)
 25 00 00 00 = tracking satellite vehicle 25
 -0019E-12- frequency offset measured in parts to 10^{-12}
 33 48.8270N = latitude 33 degrees 48.8270 minutes, north
 117 53.3864W - longitude 117 degrees 53.3864 minutes, west
 +0028 = altitude in meters
 T1 705337.512 = time interval in microseconds

* For a listing of status codes and error codes, refer to Chapter Three.

External frequency measurement or another option can be substituted for time interval if available and previously enabled.

4.44 ENTER PRESET COINCIDENCE TIME (MODEL ET6500 ONLY)

This feature provides the ability to preset a coincidence time into the GPS Time Code and Frequency Generator from hundreds-of-days through tenths of microseconds. When the coincidence time equals the GPS time, a two microsecond positive going pulse is output. For the specific output connector, refer to Chapter One.

- The user inputs \$o (Hex 24/Hex 6F). (The \$ is the attention/log-on character. The “o” is the ID ASCII character).
- Then enter sixteen ASCII digits to preset the coincidence time (starting with hundreds of days):

Example: 0562347269785673

This example shows entering the preset coincidence time of:

056 days, 23 hours, 47 minutes, 26 seconds, 978 milliseconds, 567 microseconds, and 300 nanoseconds (or 3 tenths of a microsecond).

The preset coincidence pulse occurs 200 nanoseconds late. It's pulse width is approximately two microseconds wide, positive edge on-time. It is capable of driving ten LSTTL loads.

CHAPTER FOUR

4.45 REQUEST MUX OUTPUT

This command allows the user to find out which output is selected on the four multiplexed channels. The command consists of the log-in character (\$-HEX 24), the primary character (J-HEX 4A), and the secondary character (R-HEX 52).

- The user inputs \$JR (HEX 24/HEX 4A/HEX 52).
- The unit responds with :

1 aa 2 aa 3 aa 4 aa CR/LF.

The digits 1-4 correspond to the MUX channels. “aa” (two digits) corresponds to Table 4-7.

Table 4-7
Request MUX Output

00	10MHz
01	5MHz
02	1MHz
03	100KHz
04	10KHz/2PPH*
05	1KHz
06	100Hz
07	10Hz/1PPH**
08	1Hz
09	.1Hz
10	1PPM
11	TRACKING
12	LOCKED
13	+5 Volts
14	1pps
15	DC Code

* 10KHz is output in Models ET6000 and ET6010. 2PPH is output in Model ET6500.

** 10Hz is output in Models ET6000 and ET6010. 1PPH is output in Model ET6500.

See Chapter One of this User’s Guide for specifications.

4.46 SET MUX OUTPUT

This command allows the user to select the signal output on the four multiplexed channels. The command consists of the log-on character (\$-HEX 24), the primary character (J-HEX 4A) and the secondary character (S-HEX 53).

- The user enters \$JS (HEX 24/HEX 4A/HEX 53) followed by:
aabbccdd

Where:

aa corresponds to 2 digits = Channel 1.
bb corresponds to 2 digits = Channel 2.
cc corresponds to 2 digits = Channel 3.
dd corresponds to 2 digits = Channel 4.

Note: The digits (00-15) are the same as in Table 4-7.

4.47 SET MAJOR TIME – TOD (TIME OF DAY)

This command allows the user to input and change the TOD. This command is only useful when the unit is in the “Flywheel” mode (See Chapter Three) It consists of the attention/log-on character, the command character, and nine characters representing days (day-of-year), hours, minutes, and seconds.

- The user enter \$K (HEX 24/HEX 4B) followed by:

DDDHHMMSS

- The unit responds with OK CR/LF.

4.48 SET YEAR

This command allows the user to enter two (2) digits of year into the GPS time. It consists of the attention/log-on character, the command character, and 2 characters representing year.

- The user enters \$< (HEX 24/HEX 3C) followed by two digits.
- The unit responds with OK CR/LF.

4.49 AUTOMATIC DAYLIGHT SAVINGS TIME

This feature provides the capability of offsetting the time by one hour to compensate for daylight savings time. It can be turned on and off using the front panel keyboard. It can also be programmed to automatically turn on /off for up to ten years using the RS-232 I/O port. Each time this feature is accessed from the I/O port, two commands need to be issued which consist of:

A Primary Command

- The user inputs \$O (HEX 24/HEX 4F).

A Secondary Command

One of five secondary commands can be issued (in conjunction with the primary command) to perform the following functions:

4.49.1 DISABLE AUTO DAYLIGHT SAVINGS TIME FUNCTION

This command disables the daylight savings time feature.

- The user inputs D (HEX 44).
- The unit responds with OK followed by CR/LF (carriage return/line feed).

Example: \$OD

4.49.2 ENABLE AUTO DAYLIGHT SAVINGS TIME FUNCTION

This command enables the daylight savings time feature.

- The user inputs E (HEX 45).
- The unit responds with OK followed by CR/LF.

Example: \$OE

4.49.3 SET AUTO DAYLIGHT SAVINGS TIME DEFAULT INTERVAL

This command allows the following daylight savings time intervals to be loaded into memory.

If you want the unit to automatically increment/decrement, the following command must be preceded by the ENABLE command.

- The user inputs F (HEX 46).

- The unit responds with OK followed by CR/LF.

Example: \$OF

4.49.4 REQUEST AUTO DAYLIGHT SAVINGS TIME INTERVAL

This command returns a start and stop time for a specific interval.

- The user inputs R (HEX 52) followed by an interval number of 0-9 (HEX 30 - HEX 39).
- The unit responds with:
#c Yaa Dbbb Hmm Dbbb Hmm CR/LF
where:
c = interval number (0-9)
aa = year
bbb = Julian day
mm = hour
- The first group Dbbb Hmm indicates the start time of daylight savings.
- The second group Dbbb Hmm indicates the stop time of daylight savings.

Example: \$OR3

4.49.5 SET AUTO DAYLIGHT SAVINGS TIME INTERVAL

This command allows the user to program a daylight savings time interval.

- The user inputs S (HEX 53) followed by:
caabbbmmbbbmm
where c, aa, bbb, and mm have the same weight/value as explained in the REQUEST command.

Example: \$OS4050920130102

General Specifications

If the stop time is greater than the start time, then the interval is assumed to be in the same year. If the stop time is less than the start time, then the stop time is assumed to be in the next year.

Performing a “Cold Reset” will disable the Daylight Savings time feature and load in the ten default time intervals.

CHAPTER FOUR

Each time interval must be at least two hours in duration.

Any changes must be made at least one hour prior to the next time interval.

The time intervals do not have to be programmed in sequence.

All set-ups are stored in battery backed RAM so they are retained if the unit is turned off and back on again.

Table 4-8
Automatic Daylight Savings Time – Default Values

(Default) Interval	First Sunday of April			Last Sunday of October		
	Year	Julian Day	Hour	Year	Julian Day	Hour
0	01	091	01	01	301	02
1	02	097	01	02	300	02
2	03	096	01	03	299	02
3	04	095	01	04	305	02
4	05	093	01	05	303	02
5	06	092	01	06	302	02
6	07	091	01	07	301	02
7	08	097	01	08	300	02
8	09	095	01	09	298	02
9	10	094	01	10	304	02

4.50 REQUEST UNIT SERIAL NUMBER

This command allows the user to request the unit's serial number (the same serial number that is on the rear panel).

- The user inputs \$@ (HEX 24/HEX 40).
- The unit will respond with four characters followed by CR/LF.

CHAPTER FIVE

MAINTENANCE/TROUBLESHOOTING

5.0 MAINTENANCE

This unit utilizes solid-state components. There are no moving parts (except switches etc.) or parts with limited life.

5.1 ADJUSTMENTS

Periodically the internal time base may have to be nulled/calibrated due to aging and drift of the oscillator.

5.1.1 INTERNAL OSCILLATOR CALIBRATION

It is recommended that the oscillator be nulled when the DAC value starts to approach 5,000 or 60,000.

The GPS TC&FG will have one of three oscillators installed in it:

- A voltage controlled temperature compensated crystal oscillator (TCXO) located on the GPS Main Assembly 100015 in location Y3.
- A low noise oven oscillator located on the GPS Main Assembly 100015 in location Y1.
- An X72 or LPRO rubidium oscillator attached to the bottom plate of the chassis assembly. This oscillator has no mechanical adjustment.

There are two methods to null/calibrate the internal oscillator. Use whichever method is suitable to your means and capabilities.

A. First Method

The oscillator can be nulled against a known frequency standard with an oscilloscope or other suitable means by using the following steps:

1. Turn on the unit and wait approximately one hour for the oscillator to warm up and stabilize.
2. Sync one trace of an oscilloscope on the known frequency standard. Using the other trace, monitor the 10MHz output of the unit. Remove the top cover of the unit.

3. The input of the DAC must be held static prior to the nulling oscillator. This can be accomplished one of three ways:
 - Disconnect the antenna from the rear of the unit.
 - Select the FLYWHEEL mode.
 - Disable disciplining. Refer to Chapter Four, “Disable Disciplining” in the User’s Guide.
4. Set the DAC value to it’s midpoint 32767. Refer to Chapter Four, “Enter DAC Value” in the User’s Guide.
5. The oscillator is adjusted using a plastic adjustment tool. Depending on which oscillator is installed, the adjustment screw (inside the oscillator) is in one of two locations:
 - The voltage controlled temperature compensated crystal oscillator located on the GPS Main Assembly 100015 in location Y3 has its adjustment access hole on the top of the oscillator.
 - The low noise oven oscillator located on the GPS Main Assembly 100015 in location Y1 has its access hole on the side of the oscillator. There is an access screw used to seal the oscillator that has to be removed first. Remember, after the adjustment is complete, replace the access screw.
6. Adjust the oscillator until the 10MHz output is stable with respect to the frequency standard.
7. Enable disciplining. Refer to Chapter Four, “Enable Disciplining” in the User’s Guide. Replace the top cover.
8. After approximately one hour, check the DAC value number again. If it has changed by more than ± 5000 from 32767, repeat steps two through six.

B. Second Method

If a known frequency standard is not available, the oscillator may be nulled as follows:

1. Set the unit to operate in the STATIONARY mode. Wait until the unit is LOCKED.

2. Read the DAC value either from the RS-232 I/O port, or from the LCD display.
3. Remove the top cover. Locate the oscillator and its adjustment access hole.
4. SLOWLY (no more than 45° each time) adjust the oscillator and watch the DAC value change. If the DAC value is 65535, turn the oscillator adjustment counterclockwise, which will decrease the frequency and the DAC value. If the DAC value is 00000, turn the oscillator adjustment clockwise, which will increase the frequency and the DAC value.
5. Wait approximately one minute between each adjustment to allow the oscillator to stabilize.
6. Keep adjusting the oscillator in the appropriate direction until the DAC value is approximately at its midpoint (32767). Replace the top cover.
7. If after approximately one hour, the DAC value has changed by more than $\pm 5,000$ from 32767, repeat steps one through six.

5.1.2 LCD ADJUSTMENT

The contrast of the LCD display may be adjusted using potentiometer R99.

5.1.3 AC CODE ADJUSTMENTS

The modulation ratio of the AC code output can be adjusted from a typical range of 2:1 to 6:1. It has been factory adjusted for a ratio of 3:1. The modulation ratio adjustment is potentiometer R107.

The code output amplitude (level) is adjusted using potentiometer R108. It can be adjusted to approximately eight volts peak-to-peak, terminated into 50 Ω .

5.1.4 10MHz SINE WAVE

The amplitude (level) of the 10MHz sine wave output can be adjusted using potentiometer R30. The nominal amplitude is approximately 1 volt RMS terminated into 50 Ω .

5.1.5 10MHZ SQUARE WAVE

The duty cycle (symmetry) of the 10MHz square wave output can be adjusted to approximate 50/50% using potentiometer R60. When making this adjustment, monitor the 10MHz square wave at the rear panel BNC output.

CHAPTER FIVE

5.2 TROUBLESHOOTING

5.2.1 GENERAL

If at any time the unit fails to operate or operates intermittently, it is a good idea to remove the top cover and look for any visible problems or damage. Make sure all cables are securely connected. Insure all integrated circuits are mounted into their sockets where applicable. Look for damaged components.

Because the design of the unit utilizes LSI (Large Scale Integrated) circuits, and is microprocessor based, much of the operation is controlled by firmware/software. There are few user serviceable components. If severe problems are encountered, consult the factory.

Note: When servicing the power supply, disconnect the AC power from the unit.

5.2.2 POWER LED WILL NOT ILLUMINATE WHEN ON/OFF SWITCH IS ACTIVATED

DC voltage is not present on J21 input connector pins on Assembly 100015.

Table 5-1
J21 Input Connector Pins

J21 pin 1	Ground.
J21 pin 2	-12 volts.
J21 pin 3	+12 volts.
J21 pin 4	+5 volts.

- Check the fuses in the power entry module.
- Check power wiring connections.

5.2.3 TRACKING LED DOES NOT ILLUMINATE

- Antenna/preamp is defective.
- Cable or connections between the antenna/preamp and the unit are open or intermittent.
- OnCore GPS Module (55182) is defective.

5.2.4 LOCKED LED DOES NOT ILLUMINATE

- Internal oscillator may have to be nulled/calibrated.
- Elevation Mask value may be set too high.

5.2.5 UNIT DOES NOT TRACK SATELLITES, ERROR MESSAGE/CODE – ANT. UNDERCURRENT

- Antenna/preamp failure.
- Antenna cable open or shorted (center conductor to shield).

5.2.6 COLD RESET

A “COLD RESET” needs to be performed upon the following conditions:

- The unit fails to operate or operates intermittently and it is not a power, tracking, or locked problem.

Cold Reset Procedure

- Turn off or disconnect AC power.
- While holding down the MENU key of the keyboard, reapply power and observe the LCD display to read:

COLD RESET DONE, UNIT SET TO DEFAULT
PLEASE RELEASE COLD RESET SWITCH

- Release the MENU key of the keyboard.
- The default values have now been loaded into the unit.
- Each of the above default values needs to be examined and changed/reentered as necessary. (See Section 4.31). If the unit is left in the default “AUTO” mode, it will find its own position.

Note: If new software has been installed in the unit, a cold reset will automatically be performed the first time power is applied. The following message will appear on the LCD for approximately four seconds:

COLD RESET DONE, UNIT SET TO DEFAULT

5.3 THEORY OF OPERATION

5.3.1 GPS SYSTEM OPERATION

Before going into the Theory of Operation of the ExacTime GPS Time and Frequency Generator we must first understand the operation of the GPS system and what the Satellites are providing. The GPS system is a ranging system, in which satellites inform the ground user equipment where they are located and give the time information. The function of the user equipment is to determine its position (X, Y, and Z) as well as the time (T). This is accomplished through the use of simultaneous equations. Since there are four unknowns it requires at least four satellites to solve the equations. At power-on the user equipment has no idea where it is located or what time it is. Once it has acquired (TRACKED) four satellites, it can begin the process of solving the equations. Once a position has been determined, it can be loaded into memory and used to solve for the time only. Another aspect of the GPS system that is in need of some explanation is a deterrent function known as Selective Availability (SA). This is a purposeful degradation of the GPS system's performance so that an enemy of the United States can not use the system accurately against us in time of a war. Although SA is not currently activated, it can be at any time. The degradation that takes place is from twenty-five meters to one-hundred meters Spherical Error of Probability (SEP) for position information and one-hundred nanoseconds to 300 nanoseconds 95% of the time for Time information.

5.3.2 MODES OF OPERATION

Now that we understand that a GPS is a ranging system and the user equipment must calculate its position as well as time, we will now take a look at the different MODES of operation of the equipment and understand how it affects the operation of the equipment. There are several modes of operation for the ExacTime (Auto, Stationary, Dynamic, and Flywheel). We will start off with the Flywheel mode and work our way back to the normal Auto mode.

A. FLYWHEEL MODE

Flywheel mode is a new, optional mode in which the unit is powered-on and does not operate from GPS information. The operator can set the time and the unit will function as a stand-alone clock and frequency source. No correction to the time or frequency are done by the unit, it simply continues from the last information in terms of the DAC value, position data, output selection, etc.

B. DYNAMIC MODE

The Dynamic mode of operation is a mode in that it is solving for all four variables (X, Y, Z, and T) at the same time. This mode is used either by the system to determine its location or used in a three-dimensional moving platform (i.e. aircraft). The GPS receiver used in the ExacTime is a OnCore Module. This receiver has eight channels in which to decode satellite information (what is referred to as *tracking* a satellite). Four of the channels will be collecting data from four satellites while the remaining four channels will be collecting data from as many as four more satellites in a multiplex scheme. In this way the receivers processor can be solving for the four unknowns from as many as four sets of equations at the same time. This is referred to as an “over-determined solution.” Some of the effects of SA can be smoothed out using this process. However, in this mode the time information is moving as well as a function of newly calculated positions each second. This is not the most stable timing mode to operate in, but for moving platforms it is the best mode of operation.

C. STATIONARY MODE

It is better to refer the Stationary mode as a one-dimensional mode. The receiver will use the stored position in memory and solve for the time information from as many as eight satellite at the same time. The receiver will then provide an average solution of the time information to the ExacTime, thus providing a more stable time in which to operate under the effects of SA. This is the best timing mode of operation as long as the equipment is in a static environment and a good position has been entered into memory.

D. AUTO MODE

The Auto mode is a preprogrammed mode in the ExacTime and is the default mode that the unit is shipped to the customer in. At power-on the unit does not know where it is nor what time it is, thus it must determine all of this. At power-on the Auto mode commands the receiver into the Dynamic mode of operation so that it can determine the location as well as time. The ExacTime will first set an approximate time and position as soon as it tracks four satellites. It will then begin stabilizing the internal oscillator in order to get it close to the correct frequency. After completion of the oscillator stabilization the unit will begin collecting position information. It will average the default selection of 200 positions, the unit can be set to collect as many as 99,999 positions. After the 200 positions have been collected it will command the receiver into a Stationary mode, load the average position into the receiver, set time and begin normal Stationary mode of operation. We will discuss this normal mode of operation in more detail later.

5.3.3 EXACTIME INTERNAL CONFIGURATION

The ExacTime unit is comprised of several sub-assemblies, power supplies, main clock assembly, GPS receiver, front panel LCD display, front panel keypad, optional rubidium oscillator, option motherboard, plug-in option assemblies. For the purpose of this discussion a configuration including a rubidium oscillator, 1MHz and 5MHz sine wave output options will be used in the understanding of the ExacTime's operation (please see Figure 5-1).

A POWER SUPPLY (P/N 8010-LPT4-2)

The basic power supply in this configuration is 8010-LPT4-2. This supply is used to power the ExacTime and all of the electronic assemblies (i.e. main assembly, front panel assemblies, GPS receiver, and option motherboard). It provides the system with a regulated +5 volts, +12 Volts and -12 Volts. All of the electronics use these voltages to operate within the ExacTime.. Without some or all of the voltages the unit will not operate correctly. When checking for any problem within the ExacTime it would be good to verify all of the power supply voltages to be assured they are correct. This can be done at the connector located at the supply or at the end of the power cable.

B. GPS MAIN BOARD (P/N 100015)

This main assembly is the center of the unit. It includes a microcomputer, memory, I/O interface, buffers, and all of the additional circuits to support the ExacTime's functions. The computer provides information to the front panel LCD for display of information to the operators as to the status, error, and many other operational information and selections. It interfaces to the front panel keypad and scans for operator key depressions and displays the selected information. All inputs and outputs at the rear panel with the exceptions of the ones provided by the option motherboard come from the main assembly. All outputs are buffered so as to prevent any damage to the unit should any output be shorted for any reason. Located on the main assembly is the Oncore Receiver Module as a plug-in assembly. It is held in place by four small screws and connects via an OSX connector and a multi-pin DIP connector. We will discuss the operation of the Main Assembly later in this section in more detail.

C. FRONT PANEL KEYPAD & LCD ASSEMBLY (P/N 55158)

The front panel keypad is a board that has small buttons and rubber fingers that go through the front panel to provide the operator with a colored push button and tactile feedback of a button push. The push buttons are scanned by the main assembly computer for operator entry of information or commands. This board provides the mounting for the LCD display as well. The LCD provides all of the operator information, menu selections, and operator feedback of entries. The interface is through two multi-pin ribbon cables to the Main Assembly.

D. OPTION MOTHERBOARD (P/N 35007)

The option motherboard is used in order to expand the capabilities of the ExacTime. It provides a computer buss command interface to option assemblies, if required, as well as basic 1pps, 10MHz, 5MHz, 1MHz, IRIG B and other signals that may be required for option expansion. The option slots (1-4) provide this information to optional plug-in assemblies (see the ExacTime Configuration Guide for a list of the option assemblies available). For this example the only option assemblies plugged in are the 1MHz and 5MHz sine wave shapers. The sine wave shapers simply take the 1MHz or 5MHz TTL square wave signals provided on the buss interface and provide a sine wave output to the rear panel BNC connectors on the option motherboard. The option motherboard provides buffers before the signals go the BNC connector so as to prevent and damage should the output be shorted for any reason. Additional options could be added to this configuration as there are two additional slots available for customer expansion. Should any of the option outputs fail it is a simple matter to determine if the buffer has failed or the module assembly has failed by swapping the modules. The sine wave shapers are interchangeable and can be plugged in to any slot or from another unit. Power is provided to the assembly through a parallel cable from the power supply.

E. X72 RUBIDIUM OSCILLATOR (OPTIONAL)

The internal oscillator can be an X72 Rubidium Oscillator. Its interface to the GPS Main board (100015) is through a cable assembly attached to connector J23. The 10MHz frequency output and the control voltage to adjust the frequency of the oscillator are via this cable assembly. The control voltage is provided by a digital-to-analog converter on the main assembly. It is used to discipline (control) the frequency output to the GPS reference.

5.3.4 MICROCOMPUTER PROGRAM THEORY OF OPERATION

The microprocessor clock provides a system where by the time as well as the frequencies generated are “disciplined” i.e. phase locked to the GPS reference information. Looking at Figure 5-1 there are two things that form the interface between the receiver and the clock. The first is an RS-422 I/O that provides all of the operating commands, status, and GPS data to the clock. The second is an on-time 1pps reference pulse. Once the receiver has positioned the 1pps reference, and after it begins tracking satellites, the difference (BIAS) between the 1pps reference and the real “on-time” 1pps is measured. During the “Oscillator Stabilize” phase, the clock will take this BIAS information and control the internal oscillator’s frequency to correct for any frequency offset. When the unit turns on the LOCK LED, the current BIAS information is measured again and the difference (after much filtering) is used to control the frequency of the internal oscillator.

CHAPTER FIVE

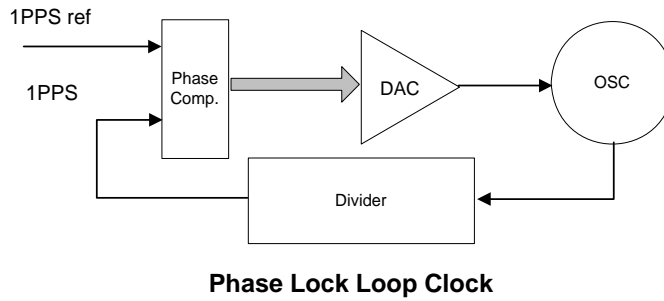

For a very simple way to look at this process we can use the above diagram of a phase lock loop to describe the function that is taking place. As you can see the 1pps that is derived from the oscillator can be controlled by the DAC so that the phase relationship is that of the measured BIAS information along with the 1pps reference. In this way all of the frequencies as well as the time information provided by the clock is “disciplined” to the GPS reference information. Both the integration (filtering) of the information in the computer as well as the oscillator stability form a very stable system especially when the oscillator is a rubidium oscillator.

MAINTENANCE/TROUBLESHOOTING

Symptom		Possible Cause	Solution
No Lights and No Display	1	No Input Power	Check AC power cord...is it correctly and firmly installed?
	2	Blown Fuse	Check if AC line fuses are open.
	3	No DC Power to (100015) Main Board	Check J21 for proper cable connection. Check J21 for correct voltages: Pin 1 - +12 Volts Pin 2 - +5 Volts Pin 3 - +5 Volts Pin 4 - Ground Pin 5 - Ground Pin 6 - -12 Volts
No Information on LCD	1	Ribbon Cable Not Connected	Check Cable for proper seating.
	2	Contrast Not Adjusted	Check pot.R99 for proper adjustment.
	3	Bad LCD	Change LCD with a known good one.
	4	LCD Drivers Bad	Change 100015 main board with a known good one. (Contact Symmetricom for repair).
Time Does Not Count	1	Bad Oncore (GPS Receiver Module)	Swap Oncore with a known good one. (Contact Symmetricom for repair).
Will Not Acquire SV's	1	No GPS Signal from Antenna	Check all antenna cable connections. Swap antenna with a known good one.
	2	No Power to Antenna (S/B + 5 Vdc on J2)	Check continuity of cable 812502-14. Swap Oncore with a known good one.
	3	DAC Level at Extremes (S/B 20000 - 40000)	Do a cold reset - See "Cold Reset" in this chapter of the User's Guide.
	4	No 10 MHz	Check 10MHz output from Oscillator.
	5	Bad Oncore	Swap Oncore with a known good one.
	6	Bad 100015 Main Board	Swap 100015 with a known good one. (Contact Symmetricom for repair).
Will Not Lock	1	10MHz not stable	Check stability of 10MHz from oscillator against a known standard.
	2	Bad Main Board	Swap 100015 with a known good one. (Contact Symmetricom for repair).
No Output from 1 or 5MHz Option	1	Amplitude too Low	Check amplitude adjustment pot on sine wave shaper board.
	2	Bad Sine wave Shaper Board	Swap shaper with a known good one. (Contact Symmetricom for repair).
	3	Bad Motherboard	Swap option motherboard with a known good one. (Contact Symmetricom for repair).
	4	Bad 100015 Main Board	Swap 100015 with a known good one. (Contact Symmetricom for repair).

CHAPTER FIVE

Symptom		Possible Cause	Solution
Cannot Communicate Via RS-232	1	RS-232 Cable Not Connected	Check RS-232 cable connection at J12 on rear panel.
	2	Wrong Parameters	Check RS-232 I/O parameters for compatibility with system.
	3	I/O Glitch	Try cold reset - See "Cold Reset" in this chapter of the User's Guide.
	4	Bad 100015 Main Board	Swap 100015 with a known good one. (Contact Symmetricom for repair).
No / Wrong Output J4-J9	1	Wrong or Missing Jumper	Check Jumper Configuration on 100015.
	2	Bad 100015 Main Board	Swap 100015 with known good. (Contact Symmetricom for repair).
Push Buttons Don't Work	1	Interface Cable Not Connected	Check cable 812515-3 for proper seating.
	2	Bad Switch	Swap front panel assembly with a known good one. (Contact Symmetricom for repair).

Figure 5-1

ET6000 Block Diagram

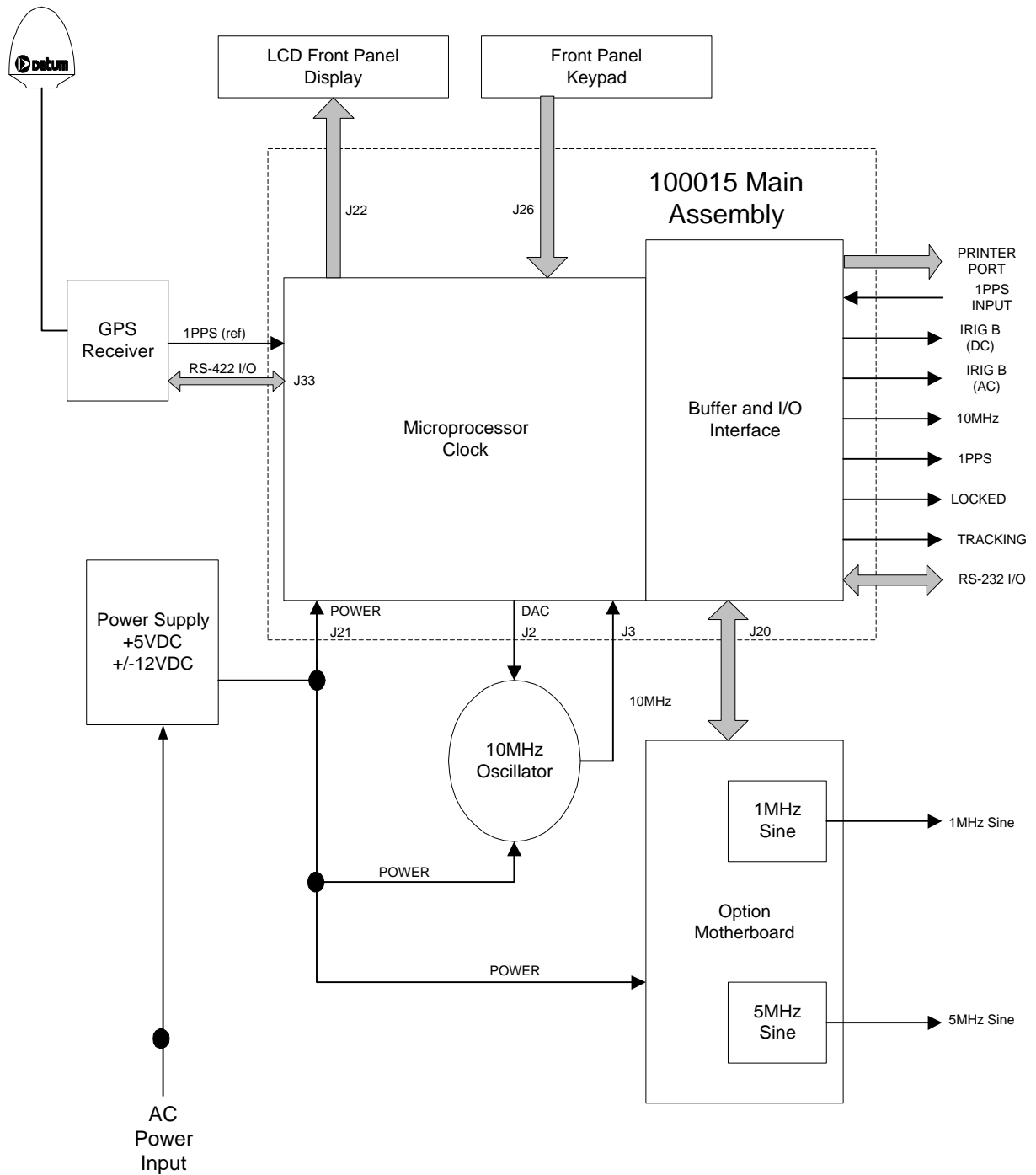

This Page Intentionally Left Blank

APPENDIX A**ASCII CHARACTER CODE TABLE****ASCII Character Code Table
Part One**

DEC	OCT	HEX	CHAR
0	000	00	NUL (^)
1	001	01	SOH (^A)
2	002	02	STX (^B)
3	003	03	ETX (^C)
4	004	04	EOT (^D)
5	005	05	ENQ (^E)
6	006	06	ACK (^F)
7	007	07	BEL (^G)
8	010	08	BS (^H)
9	011	09	HT (^I)
10	012	0A	LF (^J)
11	013	0B	VT (^K)
12	014	0C	FF (^L)
13	015	0D	CR (^M)
14	016	0E	SO (^N)
15	017	0F	SI (^O)
16	020	10	DLE (^P)
17	021	11	DC1 (^Q)
18	022	12	DC2 (^R)
19	023	13	DC3 (^S)
20	024	14	DC4 (^T)
21	025	15	NAK (^U)
22	026	16	SYN (^V)
23	027	17	ETB (^W)
24	030	18	CAN (^X)
25	031	19	EM (^Y)
26	032	1A	SUB (^Z)
27	033	1B	ESC (^[)
28	034	1C	FS (^ \)
29	035	1D	GS (^])
30	036	1E	RS (^^)
31	037	1F	US (^_)

Note: First ^ denotes the Control Key.

APPENDIX A

ASCII Character Code Table
Part Two

DEC	OCT	HEX	CHAR
32	040	20	SP
33	041	21	!
34	042	22	”
35	043	23	#
36	044	24	\$
37	045	25	%
38	046	26	&
39	047	27	,
40	050	28	(
41	051	29)
42	052	2A	*
43	053	2B	+
44	054	2C	,
45	055	2D	-
46	056	2E	.
47	057	2F	/
48	060	30	0
49	061	31	1
50	062	32	2
51	063	33	3
52	064	34	4
53	065	35	5
54	066	36	6
55	067	37	7
56	070	38	8
57	071	39	9
58	072	3A	:
59	073	3B	;
60	074	3C	<
61	075	3D	=
62	076	3E	>
63	077	3F	?

**ASCII Character Code Table
Part Three**

DEC	OCT	HEX	CHAR
64	100	40	@
65	101	41	A
66	102	42	B
67	103	43	C
68	104	44	D
69	105	45	E
70	106	46	F
71	107	47	G
72	110	48	H
73	111	49	I
74	112	4A	J
75	113	4B	K
76	114	4C	L
77	115	4D	M
78	116	4E	N
79	117	4F	O
80	120	50	P
81	121	51	Q
82	122	52	R
83	123	53	S
84	124	54	T
85	125	55	U
86	126	56	V
87	127	57	W
88	130	58	X
89	131	59	Y
90	132	5A	Z
91	133	5B	[
92	134	5C	\
93	135	5D]
94	136	5E	^
95	137	5F	_

APPENDIX A

ASCII Character Code Table
Part Four

DEC	OCT	HEX	CHAR
96	140	60	`
97	141	61	a
98	142	62	b
99	143	63	c
100	144	64	d
101	145	65	e
102	146	66	f
103	147	67	g
104	150	68	h
105	151	69	i
106	152	6A	j
107	153	6B	k
108	154	6C	l
109	155	6D	m
110	156	6E	n
111	157	6F	o
112	160	70	p
113	161	71	q
114	162	72	r
115	163	73	s
116	164	74	t
117	165	75	u
118	166	76	v
119	167	77	w
120	170	77	x
121	171	79	y
122	172	7A	z
123	173	7B	{
124	174	7C	
125	175	7D	}
126	176	7E	~
127	177	7F	DEL

APPENDIX B

GLOSSARY OF TERMS

2-D, 3-D

Refers to two-dimensional and three-dimensional positions. A 2-D position provides latitude and longitude only. In a 2-D position fix, the altitude is assumed to be fixed. Only three satellites are required to do a 2-D position. A 3-D position fix provides the altitude in addition to the latitude and longitude and requires four satellites.

- A -

ACPOS

Accurate Position.

Almanac

A reduced precision subset of the ephemeris parameters. The almanac data is used by the GPS satellite receiver to compute the elevation and azimuth angle of the satellite. Each satellite broadcasts the almanacs for all satellites.

ALT

Altitude.

Anywhere Fix

The ability of a receiver to start position calculations without being given an approximate location and appropriate time.

APPOS

Approximate Position.

ASCII

American Standard Code for Information Interchange.

Azimuth

The angle for true North of the horizontal projection of the line of sight vector measured clockwise.

AZM

Azimuth.

- B -

Bandwidth

The range of frequencies in a signal.

BIPM

Bureau International des Poids et Measurements, located in Sevres, France.

BPS

Bits per second (data transmission rate from the satellites).

- C -

Carrier

A signal that can be varied from a known reference by modulation.

Carrier Frequency

The frequency of the un-modulated fundamental output of a radio transmitter.

C/A

Coarse/Acquisition code. This is the civilian code made available by the DoD. It is also known as SPS (Standard Positioning Service).

Channel

Refers to the GPS receiver hardware that is required to lock to a satellite, make the range measurements, and collect data from the satellite.

Clock Bias

The difference between the clock's indicated time and true universal time.

Control Segment

A world-wide network of GPS monitoring and control stations that ensure the accuracy of satellite positions and their clocks.

- D -

Data Message

A 1500 bit message included in the GPS signal which reports the satellite's location, clock corrections, and health. Rough information on the other satellites in the constellation is also included.

DCE

Data Communications Equipment (See RS-232-C).

DoD

Department of Defense.

DOP

Dilution of Precision.

Doppler Shift

The apparent change in the frequency of a signal caused by the relative motion of the transmitter and receiver.

DoT

Department of Transportation.

DTE

Data Terminal Equipment (See RS-232-C).

- E -

ECEF

Earth Centered - Earth Fixed.

EIA

Electronic Industries Association.

Elevation Angle

The angle between the line of sight vector and the horizontal plane.

APPENDIX B

Elevation Mask

Refers to the angle below which a satellite is considered unusable. It is used to prevent the receiver from searching for satellites which are obscured by buildings or mountains.

Ephemeris

A set of parameters that describe the satellite orbit very accurately. It is used by the receiver to compute the position of the satellite. This information is broadcast by the satellites.

- F -

FRQ

Frequency.

- G -

GDOP

GDOP refers to the Geometric Dilution of Precision. It describes how much of an uncertainty in range affects the uncertainty in position. The GDOP depends on where the satellites are relative to the user.

A large GDOP means that a small error in range will translate into a large error in position. GDOP has two components:

PDOP (Position Dilution of Precision).

TDOP (Time Dilution of Precision).

Geoid

Refers to the actual physical shape of the earth which is hard to describe mathematically due to the irregularities of the local surface and the land-sea variations.

GMT

Greenwich Mean Time.

GMT Offset/Local Time Offset

An example of the difference between local time and GMT time is:

EST (Eastern Standard Time) minus GMT time is five hours.

GPIB

General Purpose Interface Bus (IEEE-488 Interface).

GPS

Global Positioning System. Consists of twenty-four NAVSTAR satellites in six different orbits, the ground control and monitor stations, and the user community.

- H -

Handover Word

The word in the GPS message that contains synchronization information for the transfer of tracking from the C/A to P code.

HDOP, VDOP

HDOP and VDOP are the horizontal and vertical components of the PDOP. They describe how an uncertainty in range effects the horizontal position (latitude and longitude) and the vertical position (altitude). For 2-D position fixes HDOP is all that counts.

- I -

ICD

Interface Control Document.

ID

Identification.

I/F

Interface.

I/O

Input/Output.

ION

Ionosphere/Ionospheric.

APPENDIX B

Ionosphere

The band of charged particles eighty to 120 miles above the earth's surface.

Ionospheric Refraction

The change in the propagation speed of a signal as it passes through the ionosphere.

- J -

No glossary terms have been defined for "J."

- K -

No glossary terms have been defined for "K."

- L -

L1

The primary L-Band signal radiated by each NAVSTAR satellite at 1575.42 MHz. The L1 beacon is modulated with the C/A and P codes with the NAV message. L2 is centered at 1227.60.

LAT

Latitude.

LON

Longitude.

LSB

Least Significant Bit.

- M -

MSB

Most Significant Bit.

Monitor Station

One of five world-wide stations maintained by DoD and used in the GPS control segment to monitor and control the satellite clock and orbital parameters. Corrections are calculated and uploaded to each satellite once each day.

Multipath Errors

Errors caused by the interference of a signal that has reached the GPS receiver by two or more different paths. Usually caused by one path being bounced or reflected.

- N -

NAV

Navigation.

NAV DATA

The 1500 bit navigation message broadcast by each satellite at fifty BPS (Bits Per Second) on both the L1 and L2 beacons. This message contains system time, clock correction parameters, ionospheric delay model parameters, the satellite Ephemeris and health status. This information is used to process GPS signals to obtain the users position and velocity.

NAVSTAR

The name given to GPS satellites.

NIST

National Institute of Standards Technology.

ns/nsec

Nanosecond.

- O -

No glossary terms have been defined for “O.”

- P -

P Code

The protected or military code used on both L1 and L2 GPS beacons. This code is available only to authorized users.

PDOP

PDOP refers to the Position Dilution of Precision. PDOP is composed of HDOP and VDOP. It has typically good values between two and seven. See HDOP and VDOP.

PPS

Precision Positioning Service. The most accurate dynamic positioning possible with GPS, based on dual frequency P code.

PRN

Pseudo Random Number

p/s

Picoseconds per second.

Pseudo Random Code

A signal with random noise-like proportions. It is a very complicated but repeated pattern of ones and zeros.

Pseudo-Range

A measure of the range from the GPS receiver (antenna) to the satellite. Pseudo-range is obtained by multiplying the speed of light by the apparent transit time of the signal from the satellite. Pseudo-range differs from actual range because the satellite and user clocks are offset from GPS system time by propagation delays and other errors.

- Q -

No glossary terms have been defined for “Q.”

- R -

Rise/Set Time

Refers to the period during which a satellite is visible. For example, when it has an elevation angle that is above the elevation mask. A satellite is said to rise when the elevation angle exceeds the elevation mask, and set when the elevation drops below the mask.

RS-232-C

An EIA specification.

- S -

S/A

Selective Availability. Selective availability is essentially a method for artificially creating a significant clock error in the satellites. When implemented, it is the largest source of error in the GPS system.

SCH

Schedule.

SEP

Spherical Error Probable.

SPS

Standard Positioning Service. The normal civilian positioning accuracy obtained by using the single frequency C/A code.

SS

Space Segment.

APPENDIX B

SV

Space Vehicle (GPS satellite).

- T -

TDOP

TDOP refers to the Time Dilution of Precision. It depends on the uncertainty in the clock bias.

TI

Time Interval.

- U -

μs

Microsecond.

USNO

United States Naval Observatory.

UTC

Universal Time Coordinated. The time standard maintained by the U.S. Naval Observatory. GPS Time is directly related to UTC time.

- V -

No glossary terms have been defined for “V.”

- W -

WK

Week Number.

WGS-72

World Geodetic System (1972). A mathematical reference ellipsoid used by GPS, having a semi-major axis of 6378.137 kilometers and a flattening of 1/298.26.

WGS-84

World Geodetic System (1984). A mathematical reference ellipsoid used by GPS, having a semi-major axis of 6378.137 kilometers and a flattening of 1/298.257223563.

- X -

No glossary terms have been defined for “X.”

- Y -

No glossary terms have been defined for “Y.”

- Z -

No glossary terms have been defined for “Z.”

This Page Intentionally Left Blank.

APPENDIX C

OPTION DESCRIPTIONS

GPS OPTION 01/01A

THREE CHANNEL ENCODER ASSEMBLY 55116

1.0 INTRODUCTION

This Option description provides a functional explanation of the Three Channel Encoder which can be installed inside the ExacTime unit.

Option 01 describes the modulated serial time code output code selection, specifications and adjustments. Option 01A describes the optional DC serial code output specifications.

1.1 FUNCTIONAL EXPLANATION

The ExacTime GPS Time Code and Frequency Generator has the capability of generating three modulated time code outputs on rear panel BNC connectors J3a, J3b, J3c, J3d, J3e or J3f. For the specific connections used, refer to the GPS Option/Connector Configuration sheet in the front of the ExacTime User's Guide. Each of these connectors can output any of the following codes:

IRIG A132	IRIG B122	IRIG G142	IRIG E112	IRIG E122
IRIG H112	IRIG H122	XR3	2137	NASA 36

These modulated codes are generated using the Three Channel Encoder, Assembly 55116. Code type selection is remotely selected via the RS-232 I/O Port, rear panel connector J12 or via the front panel keypad. SW4 located on Assembly 55116 (plugged into the option area of the Synchronized Time Code/Frequency Module) must have the jumper block shorting the pins.

For the optional DC Code Output, Option 01A, connectors see the GPS Option/Connector Configuration sheet in the ExacTime User's Guide.

1.2 OUTPUT SPECIFICATIONS

Note: Changing the Code Output selection may change the output amplitude. See Table 01-2 for amplitude and modulation ratio controls.

1.2.1 OUTPUT AMPLITUDE (MODULATED)

Nominal 3 volts peak-to-peak into a 50 Ω load (adjustable)

1.2.2 MODULATION RATIO

Nominal 3:1, adjustable from 2:1 to 6:1

APPENDIX C

1.2.3 DC CODE (OPTION 01A)

0 to +5 volts into a 50Ω load.

1.2.4 CONTROL VIA THE RS-232 I/O PORT

The following command allows the user to select the type of modulated output codes generated by the Three Channel Encoder (Assembly 55116). Each rear panel BNC connector (J3a, J3b, J3c, J3d, J3e, or J3f) may be individually programmed. If Option 01A (DC Code Output) is installed, see the GPS Option/Connector Configuration sheet in the User's Guide.

To Program one channel of the Encoder:

- The user inputs \$E (HEX 24) (HEX 45).
- The user inputs a digit (1 to 3) to select the specific channel.
- The user inputs a two-digit number to select the code type based on the following table:

Code Output Selection

00 = IRIG A
01 = IRIG B
02 = IRIG G
03 = IRIG E 100 Hz
04 = IRIG E 1 kHz
05 = IRIG H 100 Hz
06 = IRIG H 1 kHz
07 = XR3
08 = 2137
09 = NASA 36

- The system responds with OK CR/LF.

Example: \$E102

The above example will program Channel 1 of the Three Channel Encoder to output IRIG G on the rear panel BNC connector J3a or J3d. Refer to the GPS Option/Connector Configuration Sheet in the User's Guide.

If a cold reset was performed and the Three Channel Encoder was not programmed afterwards, all three Channels will output IRIG B.

1.2.5 CONTROL VIA THE FRONT PANEL KEYPAD

This screen provides choices on selecting the code output of the Three Channel Encoder. This screen contains the following choices:

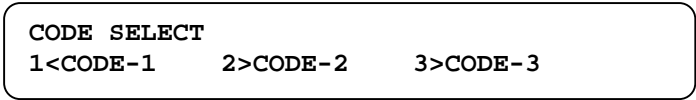

Code-1 corresponds to code output on BNC J3a or J3d.

Code-2 corresponds to code output on BNC J3b or J3e.

Code-3 corresponds to code output on BNC J3c or J3f.

The above three channels (the number 1, 2, or 3), and the screen will display the code output choices for that channel. Select the number 0-9 which corresponds to the desired output code. Then the display will return to the fourth menu screen to program the other two outputs from the Three Channel Encoder.

To return to the first menu screen, press the “MENU” keyboard switch.

If local control of this module is desired (using the DIP switches), the jumper pins located at SW4 must not have the jumper block shorting the pins. Then code output selection is made using DIP switches SW1, SW2, and SW3, located on Assembly 55116. Refer to Table 01-1 on the following page.

**Table 01-1
Modulated Time Code Output Selection**

Code	Switch Section 4	Switch Section 3	Switch Section 2	Switch Section 1
IRIG A132	Closed	Closed	Closed	Closed
IRIG B122	Open	Closed	Closed	Closed
IRIG G142	Closed	Open	Closed	Closed
IRIG E112	Open	Open	Closed	Closed
IRIG E122	Closed	Closed	Open	Closed
IRIG E112	Open	Closed	Open	Closed
IRIG H122	Closed	Open	Open	Closed
XR3	Closed	Closed	Closed	Open
2137	Closed	Closed	Closed	Open
NASA 36	Open	Closed	Closed	Open
Binary Weight	1	2	4	8

APPENDIX C

Note: Each of the three DIP switches works identically.
SW1 controls code output on rear panel BNC J3a or J3d.
SW2 controls code output on rear panel BNC J3b or J3e.
SW3 controls code output on rear panel BNC J3c or J3f.

The modulation ratio and amplitude can be individually adjusted for each of the three channels as follows:

Table 01-2
Amplitude and Modulation Radio Controls

	Channel 1 (BNC J3)	Channel 2 (BNC J5)	Channel 3 (BNC J6)
Modulation Ratio	R10	R12	R14
Amplitude	R11	R13	R15

Detailed definitions and specifications for each of the time codes that are generated by the Three Channel Encoder are provided on the following pages.

1.3 OUTPUT FORMATS

1.3.1 IRIG FORMAT A

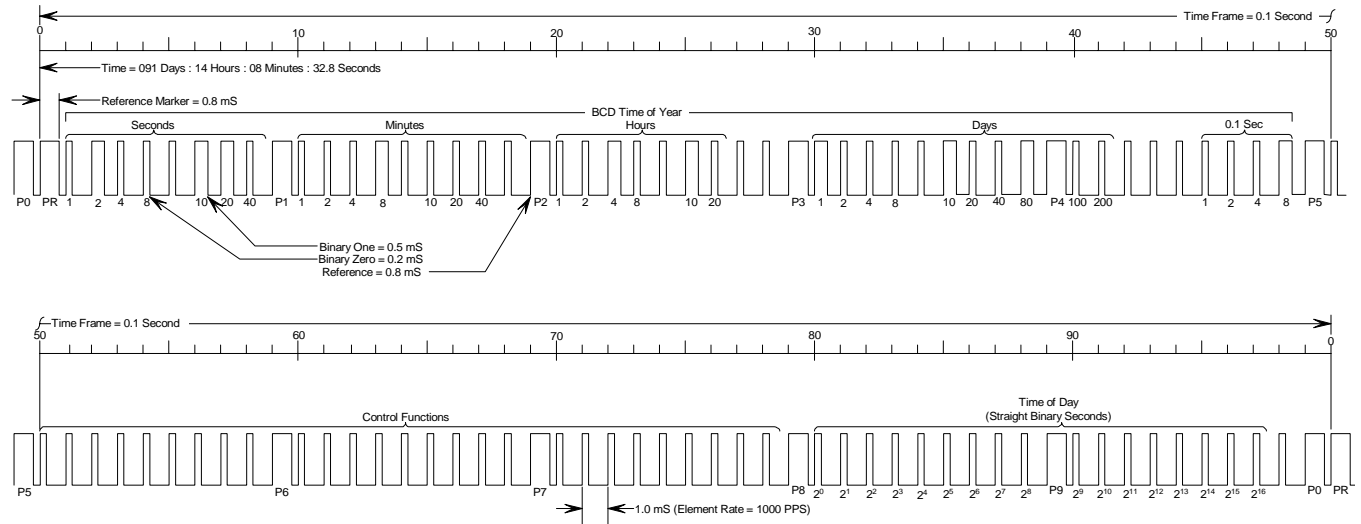

- **Time Frame:** 0.1 second. **Code Digit Weighting Options:** BCD, SB, or both.
- **Binary Coded Decimal Time-of-Year CODE WORD** - 34 binary digits.
Seconds, minutes, hours, days, and 0.1 seconds. Recycles yearly.
- **Straight Binary Time-of-Day CODE WORD** - 17 binary digits.
Seconds only. Recycles each 24 hours (86399).

Code Word Structure: BCD

Word begins at INDEX COUNT 1. Binary coded elements occur between POSITION IDENTIFIER ELEMENTS (seven for seconds, seven for minutes, six for hours, ten for days, and four for 0.1 seconds) until the CODE WORD is complete. A POSITION IDENTIFIER occurs between decimal digits in each group to provide separation for visual resolution.

Code Word Structure: SB

Word begins at INDEX COUNT 80. Seventeen binary-coded elements occur, with a POSITION IDENTIFIER between the 9th and 10th binary-coded elements.

Least Significant Digit

Occurs first, except for fractional seconds information, which occurs following the day-of-year information.

Element Rates Available

- 1000 per second (basic element rate).
- 100 per second (POSITION IDENTIFIER rate).
- 10 per second (frame rate).

APPENDIX C

Element Identification

- “On-Time” reference point for each element is its leading edge.
- INDEX MARKER duration: 0.2 milliseconds. (Binary Zero or uncoded Element.)
- CODE DIGIT duration: 0.5 milliseconds. (Binary One.)
- POSITION IDENTIFIER: 0.8 milliseconds.
- REFERENCE MARKER: Two consecutive POSITION IDENTIFIERS. (The “on-time” point, to which the CODE WORD refers, is the leading edge of the second POSITION IDENTIFIER.)

Resolution

One millisecond (unmodulated): 0.1 millisecond (modulated).

Carrier Frequency

10kHz when modulated.

1.3.2 IRIG FORMAT B

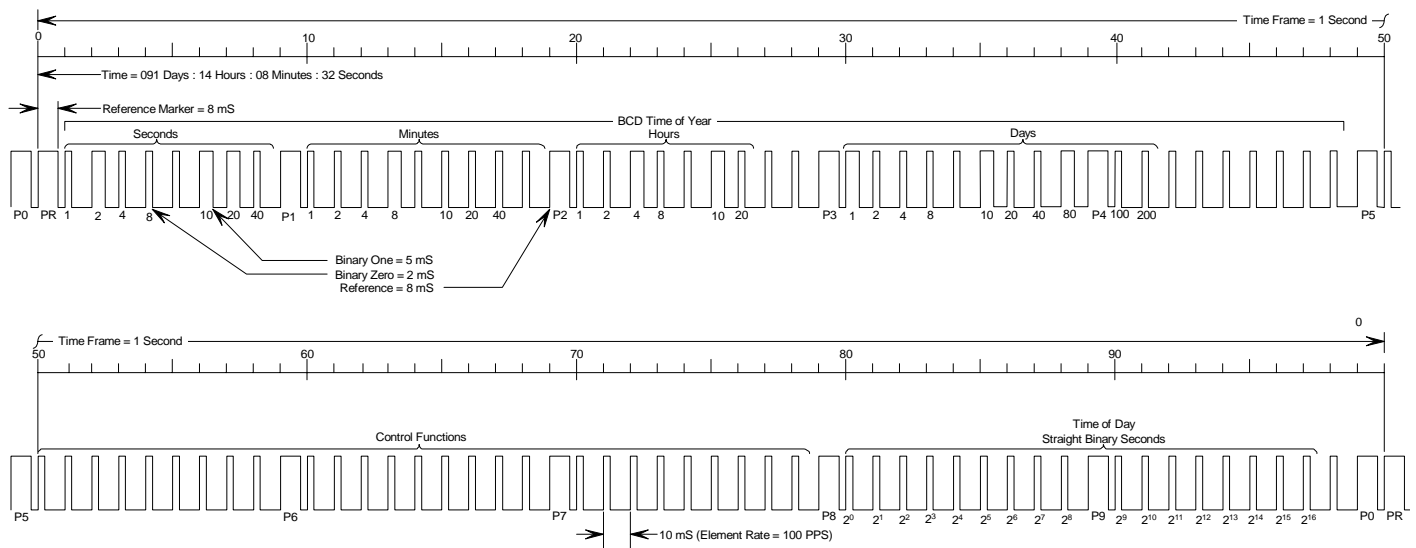

- **Time Frame:** 1 second. **Code Digit Weighting Options:** BCD, SB, or both.
- **Binary Coded Decimal Time-of-Year CODE WORD** - 30 binary digits. Seconds, minutes, hours, and days. Recycles yearly.
- **Straight Binary Time-of-Day CODE WORD** - 17 binary digits. Seconds only. Recycles each 24 hours (86399).

Code Word Structure: BCD

Word begins at INDEX COUNT 1. Binary coded elements occur between POSITION IDENTIFIER ELEMENTS (seven for seconds, seven for minutes, six for hours, ten for days) until the CODE WORD is complete. A POSITION IDENTIFIER occurs between decimal digits in each group to provide separation for visual resolution.

Code Word Structure: SB

Word begins at INDEX COUNT 80. Seventeen binary-coded elements occur, with a POSITION IDENTIFIER between the 9th and 10th binary-coded elements.

Least Significant Digit

Occurs first.

Element Rates Available

- 100 per second (basic element rate).
- 10 per second (POSITION IDENTIFIER rate).
- One per second (frame rate).

Element Identification

- “On-Time” reference point for each element is its leading edge.
- INDEX MARKER duration: 2 milliseconds. (Binary Zero or uncoded Element.)
- CODE DIGIT duration: 5 milliseconds. (Binary One.)
- POSITION IDENTIFIER duration: 8 milliseconds.
- REFERENCE MARKER: One per second. Two consecutive POSITION IDENTIFIERS. (The “on-time” point, to which the CODE WORD refers, is the leading edge of the second POSITION IDENTIFIER.)

Resolution

10 milliseconds (unmodulated): One millisecond (modulated).

Carrier Frequency

1kHz when modulated.

1.3.3 IRIG FORMAT G

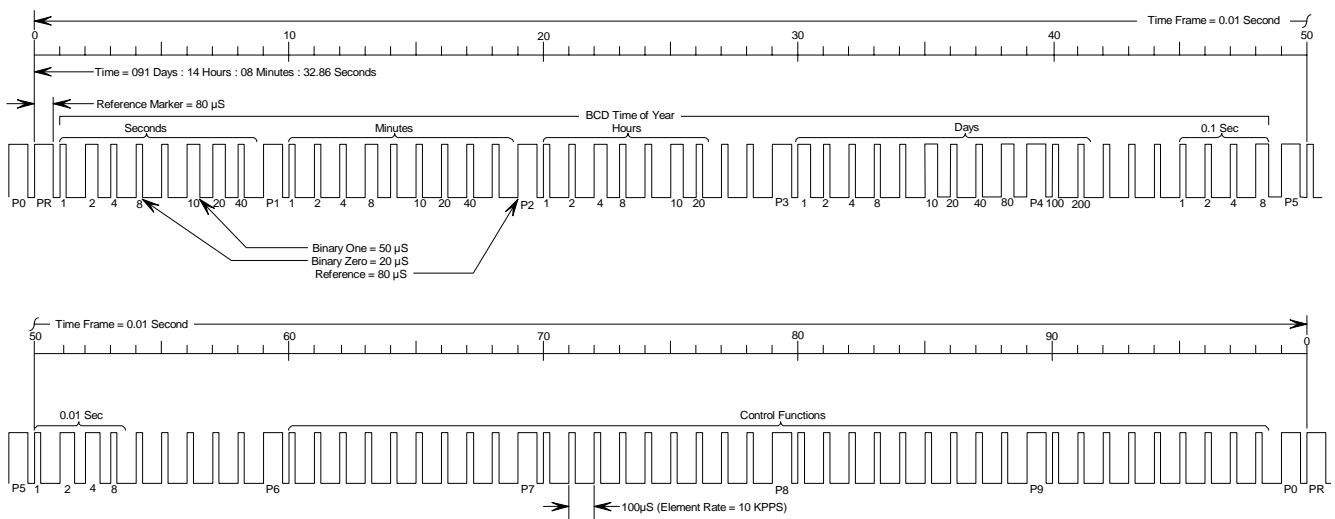

APPENDIX C

- **Time Frame:** 0.01 seconds. **Code Digit Weighting Options:** BCD Time-of-Year.
- **Code Word - 38 binary digits.** Seconds, minutes, hours, and days, 0.1 seconds, and 0.01 seconds. Recycles yearly.

Code Word Structure: BCD

Word begins at INDEX COUNT 1. Binary coded elements occur between POSITION IDENTIFIER ELEMENTS (seven for seconds, seven for minutes, six for hours, ten for days, four for 0.01 seconds) until the CODE WORD is complete. A POSITION IDENTIFIER occurs between decimal digits in each group to provide separation for visual resolution.

Least Significant Digit

Occurs first, except for fractional seconds information, which occurs following the Day-of-Year information.

Element Rates Available

- 10000 per second (basic element rate).
- 1000 per second (POSITION IDENTIFIER rate).
- 100 per second (frame rate).

Element Identification

- “On-Time” reference point for each element is its leading edge.
- INDEX MARKER duration: 0.02 milliseconds. (Binary Zero or uncoded Element.)
- CODE DIGIT duration: 0.05 milliseconds. (Binary One.)
- POSITION IDENTIFIER duration: 0.08 milliseconds.
- REFERENCE MARKER: One per second. Two consecutive POSITION IDENTIFIERS. (The “on-time” point, to which the CODE WORD refers, is the leading edge of the second POSITION IDENTIFIER.)

Resolution

0.10 milliseconds (unmodulated): 0.01 millisecond (modulated).

Carrier Frequency

100kHz when modulated.

1.3.4 IRIG FORMAT E

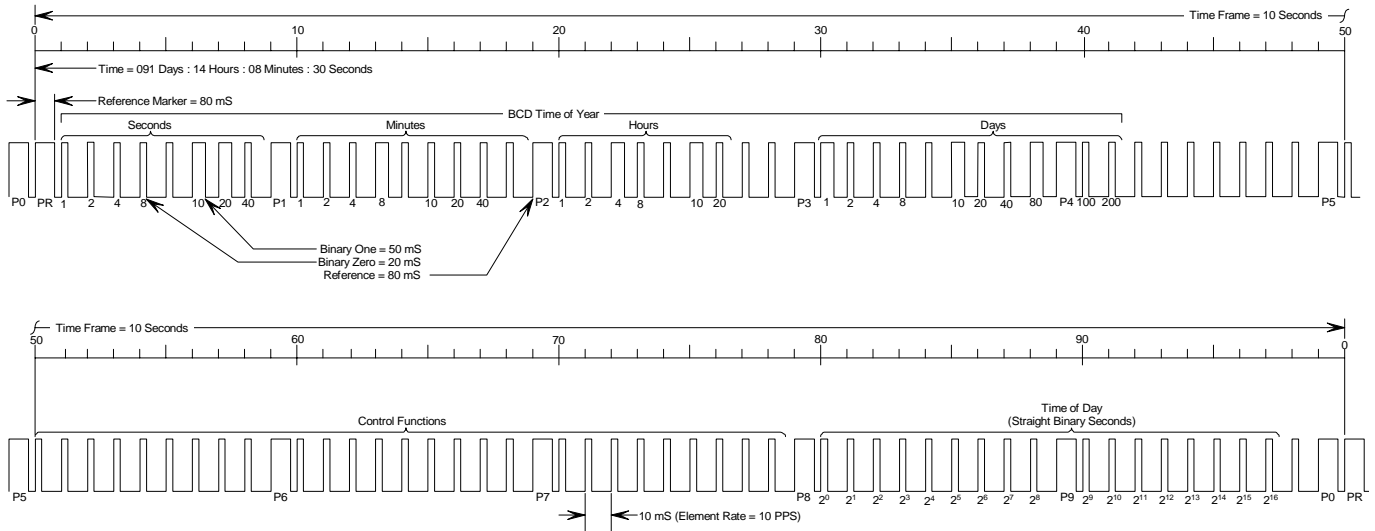

- **Time Frame:** 10 seconds. **Code Digit Weighting Options:** BCD.
- **Binary Coded Decimal Time-of-Year CODE WORD** - 26 binary digits.
Seconds, minutes, hours, and days. Recycles yearly.

Code Word Structure: BCD

Word begins at INDEX COUNT 6. Binary coded elements occur between POSITION IDENTIFIER ELEMENTS (three for seconds, seven for minutes, six for hours, ten for days) until the CODE WORD is complete. A POSITION IDENTIFIER occurs between decimal digits in each group to provide separation for visual resolution.

Least Significant Digit

Occurs first.

Element Rates Available

- 10 per second (basic element rate).
- One per second (POSITION IDENTIFIER rate).
- 0.1 per second (frame rate).

Element Identification

- “On-Time” reference point for each element is its leading edge.
- INDEX MARKER duration: 20 milliseconds. (Binary Zero or uncoded Element.)
- CODE DIGIT duration: 50 milliseconds. (Binary One.)
- POSITION IDENTIFIER duration: 80 milliseconds. (Refers to the leading edge of the succeeding elements.)
- REFERENCE MARKER: One per 10 seconds. Two consecutive POSITION IDENTIFIERS. (The “on-time” point, to which the CODE WORD refers, is the leading edge of the second POSITION IDENTIFIER.)

APPENDIX C

Resolution

100 milliseconds (unmodulated): One millisecond (modulated).

Carrier Frequency

1kHz or 100Hz when modulated.

1.3.5 IRIG FORMAT H

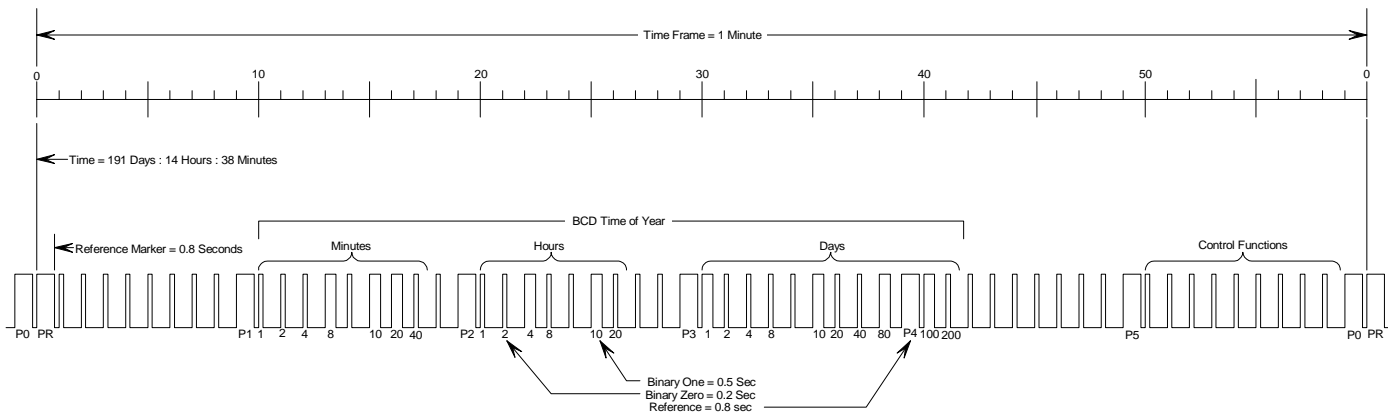

- **Time Frame:** One minute. **Code Digit Weighting Options:** BCD.
- **Binary Coded Decimal Time-of-Year CODE WORD** - 23 binary digits. Minutes, hours, and days. Recycles yearly.

Code Word Structure: BCD

Word begins at INDEX COUNT 10. Binary coded elements occur between POSITION IDENTIFIER ELEMENTS (seven for minutes, six for hours, ten for days) until the CODE WORD is complete. A POSITION IDENTIFIER occurs between decimal digits in each group to provide separation for visual resolution.

Least Significant Digit

Occurs first.

Element Rates Available

- One per second (basic element rate).
- One per ten seconds (POSITION IDENTIFIER rate).
- One per minute (frame rate).

Element Identification

- “On-Time” reference point for each element is its leading edge.
- INDEX MARKER duration: 0.2 seconds. (Binary Zero or uncoded Element.)
- CODE DIGIT duration: 0.5 seconds. (Binary One.)

- POSITION IDENTIFIER duration: 0.8 seconds.
- REFERENCE MARKER: One per minute. Two consecutive POSITION IDENTIFIERS. (The “on-time” point, to which the CODE WORD refers, is the leading edge of the second POSITION IDENTIFIER.)

Resolution

One second (unmodulated). 0.01 millisecond (modulated 100Hz). 0.001 seconds (modulated 100Hz).

Carrier Frequency

1 kHz or 100Hz where modulated.

1.3.6 XR3 FORMAT

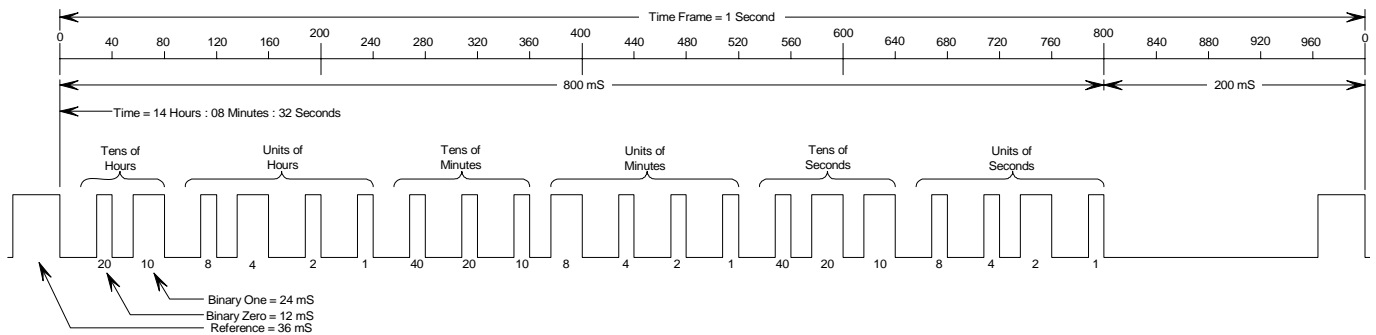

- **Time Frame:** One second. **Code Digit Weighting Options:** BCD.
- **Binary Coded Decimal Time-of-Year CODE WORD** - 20 binary digits. Hours, minutes, and seconds. Recycles every 24 hours.

Code Word Structure: BCD

Word begins at INDEX COUNT 1. Binary coded elements occur between POSITION IDENTIFIER ELEMENTS (six for hours, seven for minutes, seven for seconds) until the CODE WORD is complete.

Least Significant Digit

Occurs first.

Element Rates Available

- 25 per second (basic element rate). Four consecutive pulses missing at the end of the frame.
- One per second (frame rate).

Element Identification

- “On-Time” reference point for each element is its trailing edge.
- Binary zero duration: 12 milliseconds.

APPENDIX C

- CODE DIGIT duration: 24 milliseconds. (Binary One.)
- REFERENCE MARKER: One per second. Duration is 36 milliseconds. (The “on-time” point, to which the CODE WORD refers, is the leading edge of the second POSITION IDENTIFIER.)

Resolution

One second (frame rate, unmodulated). 40 millisecond during code word only. Four milliseconds (modulated).

Carrier Frequency

250Hz.

1.3.7 2137 FORMAT

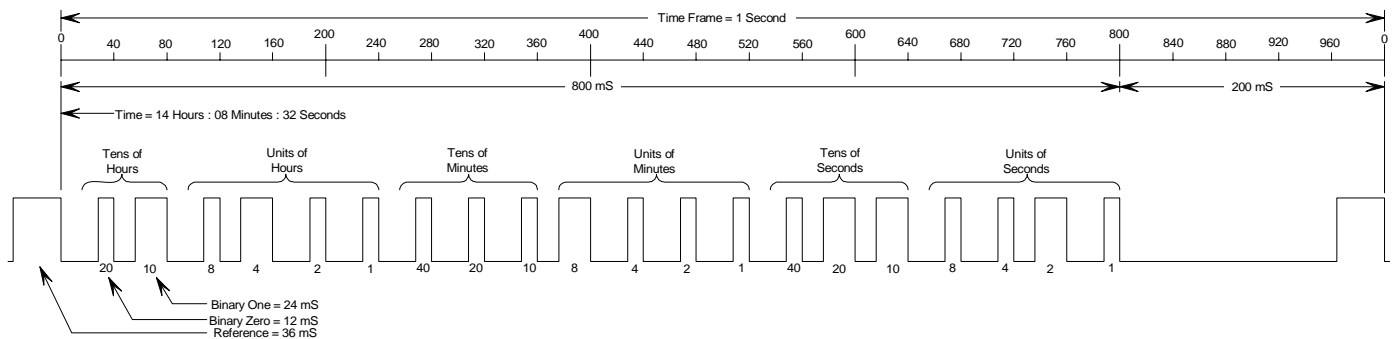

- **Time Frame:** One second. **Code Digit Weighting Options:** BCD.
- **Binary Coded Decimal Time-of-Year CODE WORD** - 20 binary digits. Hours, minutes, and seconds. Recycles every 24 hours.

Code Word Structure: BCD

Word begins at INDEX COUNT 1. Binary coded elements occur between POSITION IDENTIFIER ELEMENTS (six for hours, seven for minutes, seven for seconds) until the CODE WORD is complete.

Least Significant Digit

Occurs first.

Element Rates Available

- 25 per second (basic element rate). Four consecutive pulses missing at the end of the frame.
- One per second (frame rate).

Element Identification

- “On-Time” reference point for each element is its trailing edge.
- Binary zero duration: 12 milliseconds.

- CODE DIGIT duration: 24 milliseconds. (Binary One.)
- REFERENCE MARKER: One per second. Duration is 36 milliseconds. (The “on-time” point, to which the CODE WORD refers, is the leading edge of the second POSITION IDENTIFIER.)

Resolution

One second (frame rate, unmodulated). 40 millisecond during code word only. Four milliseconds (modulated).

Carrier Frequency

1 kHz.

1.3.8 NASA 36-BIT TIME CODE

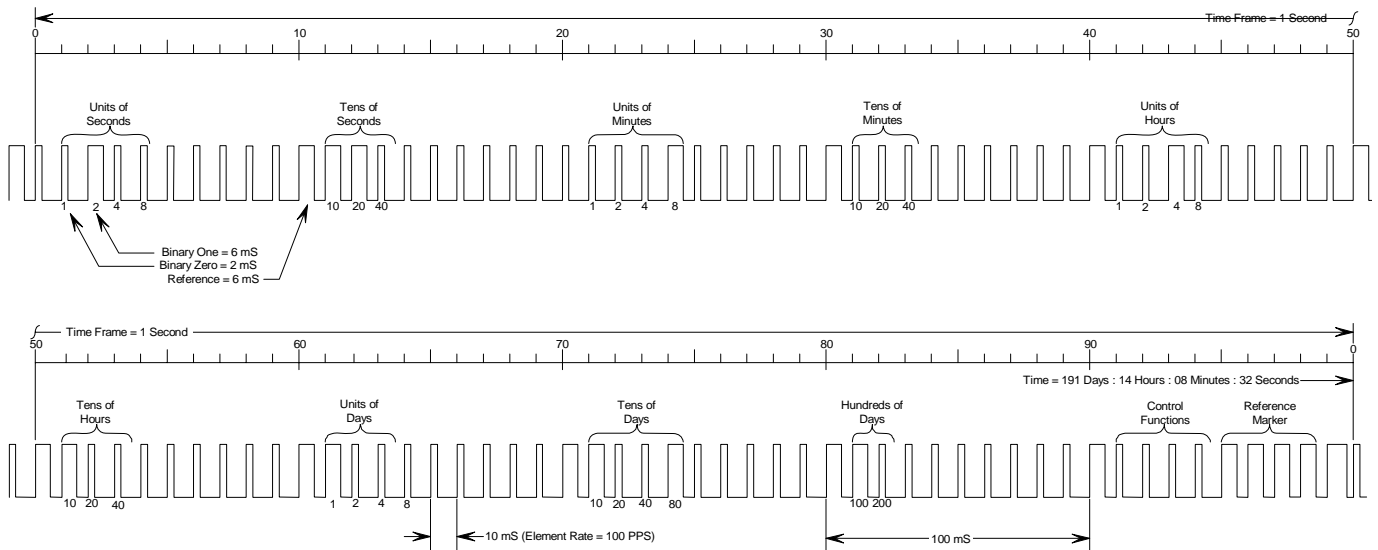

- **Time Frame:** One second. **Code Digit Weighting Options:** BCD.
- **Binary Coded Decimal Time-of-Year CODE WORD** - 30 binary digits. Seconds, minutes, hours, and days. Recycles yearly.

Code Word Structure: BCD

Word begins at INDEX COUNT 1. Binary coded elements occur between POSITION IDENTIFIER ELEMENTS in four digit groups until the CODE WORD is complete. A CODE DIGIT occurs between decimal digits in each group to provide separation for visual resolution.

Least Significant Digit

Occurs first.

Element Rates Available

- 100 per second (basic element rate).
- One per second (frame rate).

APPENDIX C

Element Identification

- “On-Time” reference point for each element is its leading edge.
- INDEX MARKER duration: Two milliseconds. (Binary Zero or uncoded Element.)
- CODE DIGIT duration: Six milliseconds. (Binary One.)
- POSITION IDENTIFIER duration: Six milliseconds.
- REFERENCE MARKER: Five consecutive POSITION IDENTIFIERS, followed by an INDEX MARKER. (The “on-time” point, to which the CODE WORD refers, is the leading edge of the INDEX MARKER following the four POSITION IDENTIFIERS.)

Resolution

10 milliseconds (unmodulated). One millisecond (modulated).

Carrier Frequency

1kHz when modulated.

ASSEMBLY 55116

NEAR SIDE OF P.C. BOARD SHOWN

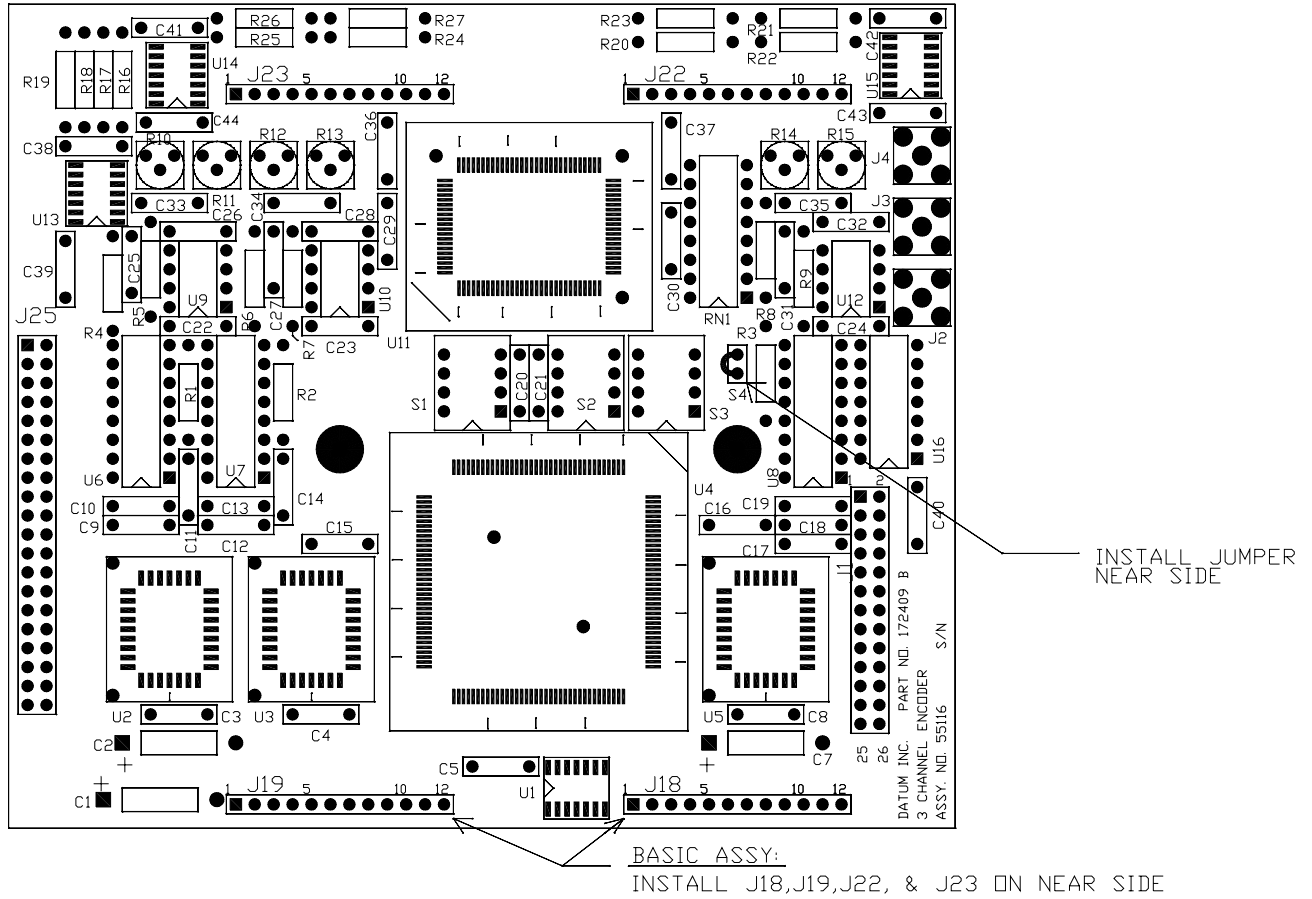

GPS OPTION 06A**1 MHZ SINE WAVE SHAPER
ASSEMBLY 20457-15****1.0 INTRODUCTION**

This option description provides Phase Noise and Harmonic specifications, an explanation of the Sine Wave Shaper logic used to develop the Sine Wave output and adjustment of the output amplitude.

This Shaper/Assembly can be plugged into the J7/J9, J8/J10, J18/J22, or J19/J23 option areas of the GPS Motherboard Assembly. The 1 MHz Sine Wave output will be present on rear panel BNCs J3B, J3C, J3E, or J3F respectively.

1.1 PHASE NOISE AND HARMONIC SPECIFICATIONS

The following specifications apply at 13dbm output level using an oven oscillator. These specifications are worst case.

Harmonics	-35 dBc
Spurious Noise	-35 dBc
Phase Noise	
1Hz	-82 dBc/Hz
10Hz	-110 dBc/Hz
100Hz	-112 dBc/Hz
1KHz	-114 dBc/Hz
10KHz	-120 dBc/Hz
100KHz	-120 dBc/Hz

1.2 FUNCTIONAL EXPLANATION

A 1 MHz square wave derived from the 10MHz internal oscillator is input to J1 pin 7 of the Sine Wave Shaper Assembly. The signal is filtered and shaped to generate the 1 MHz Sine Wave output at P1 pin 2 of the same assembly.

This signal is then routed to a rear panel BNC. Refer to the GPS Option/Connector Configuration sheet at the beginning of the ExacTime User's Guide for the output connector designation. Refer to the Top Assembly Drawing for connector location. This signal is adjustable from zero to six volts peak-to-peak and has been factory adjusted to three volts peak-to-peak into a 50Ω load.

1.3 OUTPUT AMPLITUDE ADJUSTMENT

The output amplitude of this signal can be adjusted to the desired amplitude using LEVEL potentiometer R13, on the Sine Wave Shaper assembly.

GPS OPTION 07A

**5 MHZ SINE WAVE SHAPER
ASSEMBLY 20457-25**

1.0 INTRODUCTION

This option description provides Phase Noise and Harmonic specifications, an explanation of the Sine Wave Shaper logic used to develop the Sine Wave output and adjustment of the output amplitude.

This Shaper/Assembly can be plugged into the J7/J9, J8/J10, J18/J22, or J19/J23 option areas of the GPS Motherboard Assembly. The 5 MHz Sine Wave output will be present on rear panel BNCs J3B, J3C, J3E, or J3F respectively.

1.1 SPECIFICATIONS

The following specifications apply at 13dbm output level using an oven oscillator. These specifications are worst case.

Harmonics	-35 dBc
Spurious Noise	-35 dBc
Phase Noise	
1Hz	-76 dBc/Hz
10Hz	-103 dBc/Hz
100Hz	-112 dBc/Hz
1KHz	-114 dBc/Hz
10KHz	-116 dBc/Hz
100KHz	-119 dBc/Hz

1.2 FUNCTIONAL EXPLANATION

A 5 MHz square wave derived from the 10MHz internal oscillator is input to J1 pin 7 of the Sine Wave Shaper Assembly. The signal is filtered and shaped to generate the 5 MHz Sine Wave output at P1 pin 2 of the same assembly.

This signal is then routed to a rear panel BNC. Refer to the GPS Option/Connector Configuration sheet at the beginning of the ExacTime User’s Guide for the output connector designation. Refer to the Top Assembly Drawing for connector location. This signal is adjustable from zero to six volts peak-to-peak and has been factory adjusted to three volts peak-to-peak into a 50Ω load.

1.3 OUTPUT AMPLITUDE ADJUSTMENT

The output amplitude of this signal can be adjusted to the desired amplitude using LEVEL potentiometer R13, on the Sine Wave Shaper assembly.

GPS OPTION 08CE

10-37VDC DUAL POWER INPUT ASSEMBLY 100002

1.0 INTRODUCTION

This option provides the ability to use one of two DC sources to power the GPS TC&FG.

1.1 FUNCTIONAL EXPLANATION

Two separate DC inputs labeled J1A and J2A and a On/Off switch are located on the rear of the unit. These inputs are routed through the switch, separate fuses and bridge rectifiers, and connected together to the input of a single DC/DC converter. This DC/DC converter supplies +5 and +/-12VDC to power the unit.

Because the two DC inputs are routed through bridge rectifiers, the individual input pins are not polarity sensitive. Because the outputs of the two bridge rectifiers are connected together to form the input to the DC/DC converter, which ever input is the higher DC voltage will power the unit. If the higher DC input is lost (or not present), the other DC input will power the unit.

1.2 SPECIFICATIONS

Input Voltage/Current: +10VDC to +37VDC.
Approximately 1.5 amps @ +10VDC.
Approximately .5 amps @ +37VDC.

Note: The input current is dependent on the number of options installed in the GPS TC&FG.

Internal Fuses: F1 protects DC input from connector J1A.
F2 protects DC input from connector J1B.
Fuses are 4 amp, slow blow, 5x20 millimeters (located on Assembly 100002).

Input Connector Pin Assignments:

Input 1

J1A pin 1	DC Input 1
J1A pin 2	Chassis Ground
J1A pin 3	DC Input 1 Return (Signal Ground)

Input 2

J1B pin 1	DC Input 2
J1B pin 2	Chassis Ground
J1B pin 3	DC Input 2 Return (Signal Ground)

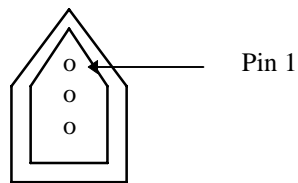

ASSEMBLY 100002

NEAR SIDE OF P.C. BOARD SHOWN.

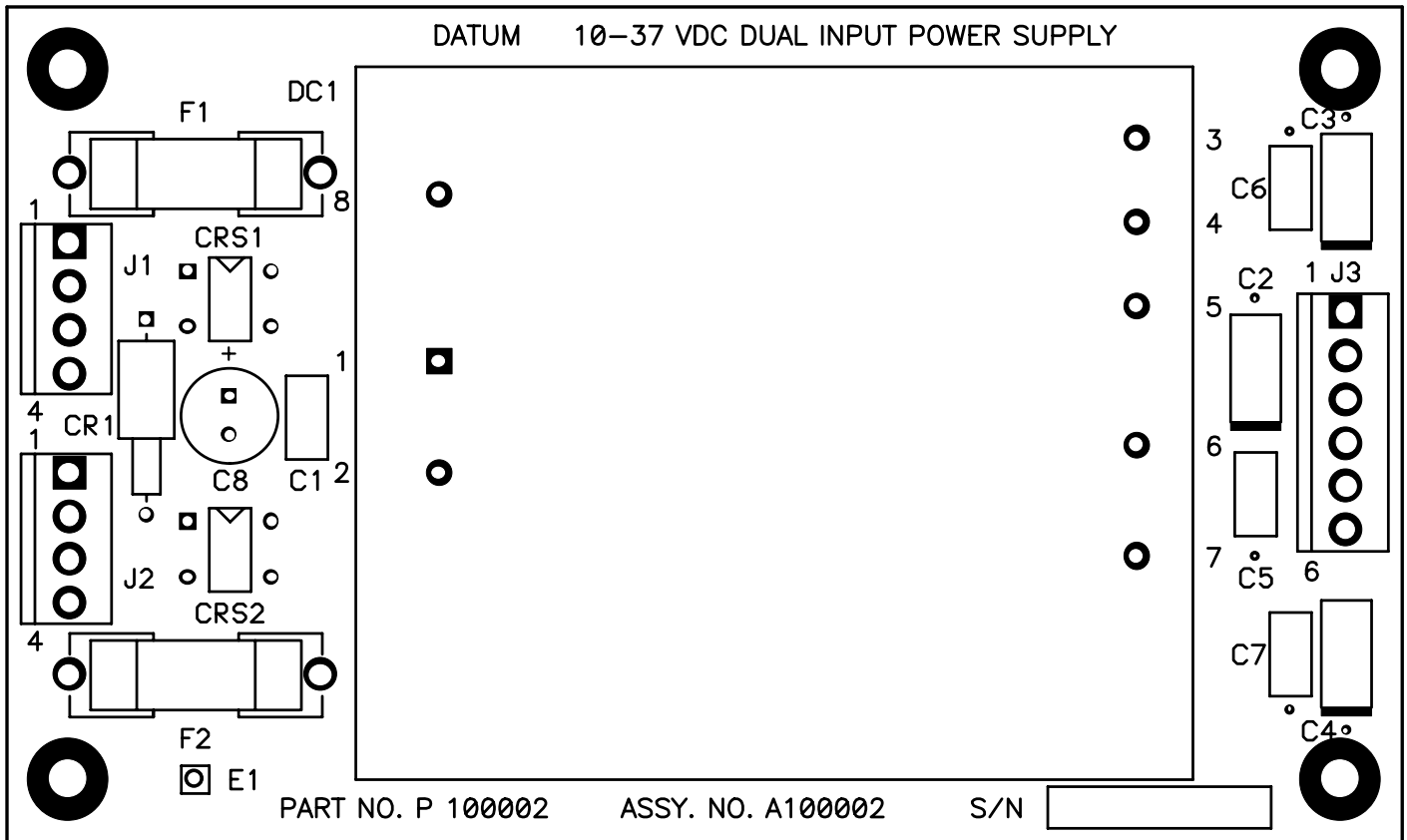

APPENDIX C

1.2 OPERATION

This option has two DC inputs A and B. These dual inputs provide for a backup supply. If one supply goes down, the other takes over. The dual inputs are diode 'ORed' together using bridge rectifiers. Because of this, the DC input with the higher voltage will be used to power the unit.

Even though the inputs are labeled + and - , it really doesn't matter how they are connected. The labeling is to eliminate confusion. Both inputs have 1 amp (normal blow) fuses for protection.

1.3 TEMPERATURE

The operating temperature of the unit should not exceed +40°C. This limitation is due to the fact that there is no forced air flow over the DC-DC converter.

GPS OPTION 08GP

**38-73VDC POWER SUPPLY
ASSEMBLY 55187**

1.0 INTRODUCTION

This option takes a nominal input of 48V through a rear panel terminal strip and provides +5 and ±12 VDC to power the GPS Time Code and Frequency Generator. It also provides timing and fault status relay closures.

Optionally it can provide the capability of measuring the frequency, phase angle, and elapsed time offset of an externally applied fifty or sixty AC sine wave.

All input/outputs from Assembly 55187 are from a rear panel terminal strip TB1.

All input/outputs have metal oxide varistors for transient voltage suppression.

The pin assignments for TB1 are shown below (as viewed from the rear of the unit):

Figure One

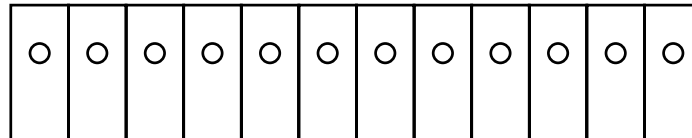

TB1-1

TB1-12

Pin Assignments

TB1-1	DC In 1
TB1-2	DC In 1 Return
TB1-3	Chassis Ground
TB1-4	Fault Relay - Common Contact
TB1-5	Fault Relay - Normally Closed Contact
TB1-6	Timing Relay - Common Contact
TB1-7	Timing Relay - Normally Closed Contact
TB1-8	50/60Hz Measurement Input - HI
TB1-9	50/60Hz Measurement Input - LO
TB1-10	DC In 2 (optional)
TB1-11	DC In 2 Return (optional)
TB1-12	Chassis Ground (optional)

APPENDIX C

1.1 SPECIFICATIONS

DC Input Voltage Range: DC = 38-73 VDC

DC Input Current (Max.) @ 38V: .6 amps

DC Input Current (Max.) @ 73V: .3 amps

Note: The input current is dependent on the number of options installed in the GPS TC&FG.

Fault Relay: Closure on fault.

Timing Relay: Closure when not locked.

Relay Contact Ratings: 10 watts, 0.5 amps, 200 volts.

50/60Hz Measurement Input: 85-250 VAC.

1.2 OPERATION

This option has two relay closures to indicate timing/fault of the unit. The fault relay output on the rear panel terminal strip TB1-4 and 5 will provide contact closure upon the following conditions:

A processor error, Channel One error, or Channel Two error from the GPS receiver (SVee Six Module).

Loss of +5VDC.

If the DAC value goes below 300 or above 65,000.

The timing relay (output on the rear panel terminal strip TB1-6 and 7) provides a contact closure until the unit has achieved oscillator lock. For example, until the front panel LOCKED LED illuminates.

Operation of the optional 50/60Hz measurement feature is as follows:

With the unit operating, connect the AC measurement source to TB1-8 and TB1-9 (50/60Hz Measurement Input). Make sure that when plugging in the cable to the AC power source that it is correctly polarized. For example, the pin labeled AC HI (50/60Hz Measurement Input - HI) is plugged into the AC HOT receptacle. If this connection is reversed, the phase angle measurement will be off by 180°.

The frequency measurement is made by counting the number of 50/60Hz sine waves occurring between successive corrected 1pps pulses from the GPS receiver.

The phase angle measurement is made by calculating where the 1pps pulse occurs in relationship to the 50/60Hz sine wave.

The error calculation is the accumulated time error based on whether the sine wave is fast or slow. A time error offset can be entered when the 50/60Hz measurement is OFF, which is used as a starting point for the error calculation.

The 50/60Hz measurement features can be programmed using the front panel keypad switches. Cycle through the various menus on the LCD display, using the MENU switch, until the 50/60Hz measurement screen appears. It will look similar to the following:

```
FRQ:60.0001Hz PHASE:123.4° ERR:-0.431 S
1>OFFSET:+0.0000S<4>OFF<5>ON<6>60Hz/ OFF
```

Pushing keypad switch number one will program the offset. Note that an offset cannot be entered until the measurement is stopped. OFF will appear in the lower right hand corner of the LCD display. If the unit is not locked, ERR will appear. If the measurement is started, ON will appear. Keypad switch number two will select “+” (plus) and switch number three will select “-” (minus). The number of seconds offset can then be entered using the keypad switches up to 9.9999 seconds.

Pushing the number four key will stop the measurement, and OFF will appear on the LCD display in the lower right-hand corner.

Pushing the number five key will start the measurement, and ON will appear after the <5>. If the unit is not locked, ERR will appear in the lower right hand corner of the LCD display.

Pushing the number six key of the keypad selects either 50Hz or 60Hz. 50Hz or 60Hz selection can only be done when the unit is not doing measurements. OFF is displayed in the lower right hand corner of the LCD display.

The following features are input/selected via the RS-232 I/O port:

1.3 50/60Hz SELECTION

This command allows the user to select either the 50Hz or 60Hz measurement features.

- The user inputs \$L (HEX 24, HEX 4C) followed by either a zero or a one. (Zero for 50Hz measurement, one for 60Hz measurement.) If the unit is not doing measurements, the RS-232 will respond with OK (CR) (LF), otherwise the unit will respond with ? (CR) (LF).

1.4 ENABLE/DISABLE 50/60Hz MEASUREMENT

This command allows the user to enable or disable the 50/60Hz measurement feature.

- The user inputs \$B (HEX 24, HEX 42) followed by either a zero or a one. Zero turns the option OFF, and one turns the option ON.

APPENDIX C

- The unit responds with OK CR/LF.

Example: \$B1

The above example illustrates enabling the 50/60Hz measurement option.

If the option is turned ON (enabled) and it isn't available, the message "OPT?" will be sent.

1.5 ENTER 50/60Hz OFFSET DATA

This command allows the user to enter a starting point for the time error calculation.

- The user inputs \$D (HEX 24, HEX 44) followed by one digit (sign), decimal point, followed by four digits. The sign digit's definition is 1 = + (plus) and 0 = - (minus).
- The unit responds OK CR/LF.

Example: \$D 02.3406

The above example illustrates entering a time error offset of -2.0346 seconds.

Note: The time error offset can only be entered if the 50/60Hz measurement option is OFF.

If a time offset is entered while the 50/60Hz option is enabled, the message OPT ON will be sent, and the time offset data is ignored.

The offset is stored in battery backed RAM, so it will be retained if the unit is turned OFF and then back ON again.

1.6 REQUEST 50/60Hz MEASUREMENT DATA

This command allows the user to obtain the 50/60Hz measurement data.

- The user enters \$A (HEX 24, HEX 41).
- The unit responds with XX.XXXX, space, Hz (representing frequency measurement), space, ±X.XXX, space, SEC (representing accumulated time error), space, XXX.X space, DEG (representing phase angle measurement), space +X.XXXX, space, OFFSET (representing time offset), CR/LF.

Example: 60.1324Hz + 1.357SEC 180.2DEG + 1.206 OFFSET CR/LF

The above response states that the frequency measurement is 60.1324Hz, and the accumulated time error is +1.206 seconds.

OPTION DESCRIPTIONS

The 60Hz measurement data is also available on the 50/60Hz measurement screen of the front panel LCD display. The format is as follows:

```
FRQ: 60.1324HZ PHASE: 180.2° ERROR: +1.357  
1>OFFSET:+1.206S<4>OFF<5>ON<6>60HZ/ ON
```

If the 50/60Hz option is not enabled, ON will be replaced by OFF. When the unit is first turned on, it will come up in the OFF (default) mode. If the 50/60Hz option is turned on prior to the unit achieving LOCK, ON will be replaced by ERR and measurement data will not be available.

When measuring the 60Hz with a time period of 16.66 milliseconds, if a measurement occurs outside a one millisecond window of that time period (such as a noise spike), the measurement is ignored, and an error is counted. If 1,000 successive errors are read, the message ERR appears, and the 60Hz measurement option is turned OFF.

GPS OPTION 10B**LOW PHASE NOISE OSCILLATOR
PIEZO****1.0 INTRODUCTION**

This option provides an internal disciplined 10MHz Oven Oscillator as the unit's time base. This 10MHz time base is frequency corrected using a DAC (Digital to Analog Converter) and locked to the GPS corrected 1PPS.

1.1 SPECIFICATIONS

Output Frequency/ Waveform:	10MHz sine wave
Output Amplitude:	1.0 VRMS into 50Ω
Aging Rate:	+5 x 10 ⁻¹⁰ per day +1.5 x 10 ⁻⁸ per year
Temperature Stability:	+3 x 10 ⁻⁸ over a temperature range of -20°C to +75°C
Operating Temperature:	-20°C to +75°C
Altitude:	Sea level to 50,000 feet
Electrical Tuning:	+1PPM (minimum) +2PPM (maximum)
Control Voltage:	0 to 6 Volts
Mechanical Frequency Adjust:	+1PPM (minimum) +3PPM (maximum)

The following specifications apply to the Selected 10 MHz Output at a 13dbm output level.:

Harmonics:	-35 dBc
Spurious Noise:	>-35 dBc
Phase Noise:	
1Hz	-85 dBc/Hz
10Hz	-113 dBc/Hz
100Hz	-134 dBc/Hz
1KHz	-144 dBc/Hz
10KHz	-148 dBc/Hz

It is recommended that the oscillator be nulled when the DAC value starts to approach either extreme of 5,000 or 60,000. There is a hole on the left side panel of the unit for the oscillator adjustment. The screw must be removed to provide access to this adjustment.

There are two methods to null/calibrate the internal oscillator.

1.2 CALIBRATION - FIRST METHOD

The oscillator can be nulled against a known frequency standard with an oscilloscope or other suitable means by using the following steps:

1. Turn on the unit and wait approximately one hour for the oscillator to warm up and stabilize.
2. Sync one trace of an oscilloscope on the known frequency standard. Using the other trace, monitor the 10MHz output of the unit.
3. The input of the DAC must be held static prior to nulling the oscillator. This can be accomplished one of three ways:
 - Disconnect the antenna input from the rear of the unit.
 - Select the single satellite mode (1SV), and select a satellite that is not in view (or pick SV33 which doesn't exist).
 - Disable disciplining, refer to Chapter Four, "Disable Disciplining" in the User's Guide.
4. Set the DAC value to it's midpoint 32767. Refer to Chapter Four, "Enter DAC Value" in the User's Guide.
5. Adjust the oscillator until the 10MHz output is stable with respect to the frequency standard.
6. Reinstall the screw. Enable disciplining. Refer to Chapter Four, "Enable Disciplining" in the User's Guide.
7. After approximately one hour, check the DAC value number again. If it has changed by more than ± 5000 from 32767, repeat steps two through six.

1.3 CALIBRATION - SECOND METHOD

If a known frequency standard is not available, the oscillator may be nulled as follows:

1. Set the unit to operate in the single satellite (1SV) mode. Make sure the unit is tracking a satellite.
2. Read the DAC value either from the RS-232 I/O port, or from the LCD display.
3. The oscillator is located on the GPS Main Assembly 35002 in location Y1. Remove the oscillator adjustment access screw to provide access to the oscillator adjustment.
4. SLOWLY (no more than 45° each time) adjust the oscillator and watch the DAC value change. If the DAC value is 65535, turn the oscillator adjustment counterclockwise which will decrease the frequency and the DAC value. If the DAC value is 00000, turn the oscillator adjustment clockwise which will increase the frequency and the DAC value.

APPENDIX C

5. Wait approximately one minute between each adjustment to allow the oscillator to stabilize.
6. Keep adjusting the oscillator in the appropriate direction until the DAC value is approximately at its midpoint (32767).
7. Install the screw in the oscillator adjustment access hole.
8. If after approximately one hour, the DAC value has changed by more than $\pm 5,000$ from 32767, repeat steps one through six.

GPS OPTION 13A PARALLEL BCD OUTPUT DAYS –MILLISECONDS ASSEMBLY 55128

1.0 INTRODUCTION

This option provides a precision time output consisting of BCD day of year, hours, minutes, seconds, and milliseconds.

Optionally, three selectable rate outputs can also be provided on separate BNC connectors.

1.1 SPECIFICATIONS

Parallel BCD time, in conjunction with cable assembly 812362-27 output on a 50 pin 3M ribbon type connector.

1.1.1 OUTPUT CHARACTERISTICS

All outputs are positive true logic, except where noted. HCMOS compatible. Each output capable of sinking and sourcing four milliamperes.

1.1.2 MATING CONNECTOR

The suggested mating connector is 3M, manufacturer's Part Number 3425-6000 or 3425-6050 or equivalent.

1.1.3 PIN ASSIGNMENTS

See Table One.

Two sample time pulses are provided in the connector J3B. One sample time pulse is at the least significant bit (LSB) rate:

Connector J3B Pin 38 is 1pps (STP 1P).
Connector J3B Pin 48 is 1kpps (STP 1K).

APPENDIX C

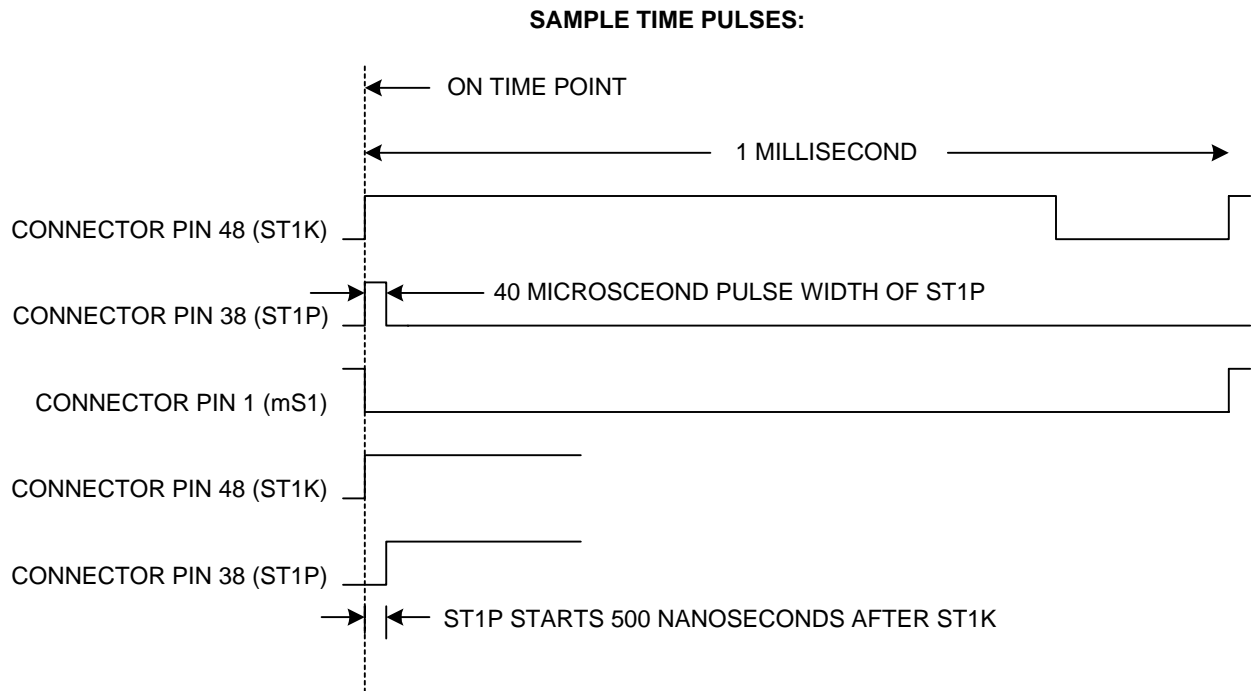

Both pulses have a 20/80 duty cycle. When the pulse is low, the data is changing and is not valid. When the pulse is true, the data is stable/valid and can be sampled.

For the rear panel connector designation and location, refer to the GPS Option/Connector Configuration sheet at the beginning of the ExacTime User's Guide accompanying this Option Description.

1.2 OPERATION

This operation applies only to the three optional pulse rate outputs.

For the purposes of this Option Description, Channel One equates to Output One, Channel Two equates to Output Two, and Channel Three equates to Output Three.

The three selectable pulse rate outputs can be programmed to provide the following rates:

1 10 2400.

The three selectable pulse rates can be programmed from the front panel using the keypad. Cycle through the various menu screens using the MENU switch until the PULSE RATES screen appears.

- Sequentially pushing keyboard Switch One will cycle through the three channels.

- Sequentially pushing keyboard Switch Two will cycle through the various pulse rates, starting with 1pps.
- When all the parameters are selected for a channel (output), the #4 keyboard switch must be pushed for them to be entered.

The selectable pulse rates can also be controlled/programmed via the RS232 I/O. To set up the pulse rates, the user must perform the following steps:

The user enters \$f (HEX 24/HEX 46) followed by six digits.

The first digit (after log-on and I.D. characters) is the channel (output) select.

0 = Channel One
 1 = Channel Two
 3 = Channel Three

The next two digits are a code to select the pulse rate.

01 = 1pps
 02 = 10pps
 03 = 2400pps

The last three digits are required for a complete command, but any digit can be entered because they aren't used.

Example: \$F103XXX

The above example indicates the user selecting Channel Two to have a pulse rate of 2400pps.

The unit responds with OK CR/LF

To request a pulse rate via the RS-232 I/O, the user performs the following steps:

The user enters \$G (HEX 24/HEX 47).

Channel (output) number
 Space
 Four digits of pulse rate followed by pps
 space
 (the above is repeated for each channel followed by CR/LF).

APPENDIX C

Example: 1 1 2 2400 3 10 CR/LF

The above example illustrates Channel One with a pulse rate of 1 pps, Channel Two with a pulse rate of 2400 pps, and Channel Three with a pulse rate of 10pps, carriage return/line feed.

Table One
J3B
Rear Panel Connector Pin Assignments

Pin	Signal	Pin	Signal
1	mS1	26	D20
2	M40	27	S2
3	mS2	28	D40
4	H1	29	S4
5	mS4	30	D80
6	H2	31	S8
7	mS8	32	D100
8	H4	33	S10
9	mS10	34	D200
10	H8	35	S20
11	mS20	36	GND
12	H10	37	S40
13	mS40	38	ST1P
14	H20	39	M1
15	mS80	40	GND
16	D1	41	M2
17	mS100	42	N/U
18	D2	43	M4
19	mS200	*44	UNLOCKED
20	D4	45	M8
21	mS400	46	GND
22	D8	47	M10
23	mS800	48	ST1K
24	D10	49	M20
25	S1	50	GND

* True when unit is unlocked. Low when unit is locked.

GPS OPTION 14**IEEE-488 I/O INTERFACE
ASSEMBLY 55089 OR 55115****1.0 INTRODUCTION**

This assembly is designed in accordance with the IEEE-488/1978 specification and is used to provide the electrical interface between the GPS Time Code and Frequency Generator (TC & FG) and the IEEE-488 bus.

When programmed as a listener, this assembly provides the capability to remotely control the TC & FG. When programmed as a talker, this assembly provides the capability to output time, status, location, etc. Five of the eight bus control lines (DAV, NRFD, NDAC, ATN and IFC) are used in this option. EOI, SRQ and REN have no assigned function. The controller cannot perform a serial poll of this assembly.

It is not recommended that the IEEE-488 and the RS-232 I/O be operated simultaneously.

1.1 INSTALLATION

This assembly is plugged into and works in conjunction with the motherboard option (GPS Option 40) of the time code and frequency generator. Interconnection to the IEEE-488 bus is provided through rear panel connector J13. Refer to the GPS Option Connection/Configuration sheet in the User's Guide.

1.2 OPERATION

The first step in using the IEEE-488 I/O port is to program/select the Device Address. The current IEEE-488 address may be found by pressing the front panel MENU keypad switch until the IEEE-488 screen (as shown below) is displayed on the LCD display.

```
<1> IEEE488 ADDR.17
```

If desired, the address may be changed by pressing the 1 key of the keypad, which causes the two digits following ADDR. to change to "xx" prompting the user to enter a two digit address. A leading zero is required if address is less than 10.

If a cold reset was performed at power up, the default address will be 17. The address can be changed by closing (pushing down) rear panel DIP switch SW2, position 3. Watch the display, and the address will increment at one second intervals.

When the desired address is reached, open (push up) DIP switch SW2, position 3. The Device Address can also be selected via the RS-232 I/O port. The user inputs \$CXX. (The XX corresponds to a two digit device address number). The unit will respond with OK CR/LF (carriage return/line feed).

All communication to or from the IEEE-488 port is in the ASCII format. At power up, the interface is in the wait/idle state. To talk to our interface, send the following commands/mnemonics in the order listed below:

- UNL (unlisten)
- MTA (my talk address containing the address of the controller)
- LAG (listen address group containing the address of our interface)
- The attention/log-on character (see Section 4.1 of the main Manual)
- The command/ID character
- The specific data (if applicable).

Note: With the exception of UNL, MTA, and LAG, the protocol is identical to that of the RS-232 I/O. When communicating to the 488 interface, if more than 30 seconds elapses between commands, the I/O will time out and the communication will have to be repeated.

If after talking to our interface, it is necessary to receive some data, send the following commands/mnemonics:

- UNL (unlisten)
- MLA (my listen address containing the address of the controller)
- TAG (talker address group containing the address of our interface).

Our interface will always respond with specific data followed by CR/LF.

1.3 MAINTENANCE

No routine maintenance is required.

Table One
IEEE-488 Bus Interface Connector Pin Assignment

J13 Pin	Signal
1	D101
2	D102
3	D103
4	D104
5	EOI
6	DAV
7	NRFD
8	NDAC
9	IFC
10	SRQ
11	ATN
12	GND
13	D105
14	D106
15	D107
16	D108
17	REN
18	GND
19	GND
20	GND
21	GND
22	GND
23	GND
24	GND

Table Two
Applicable Command/Character ID

ASCII Char	HEX Char	Description	Format/Response
`	60	Symmetricon Firmware Version	User's Guide
c	63	UTC Sync	User's Guide
d	64	GPS Sync	User's Guide
e	65	Print Frequency Offset	User's Guide
f	66	Print Time, Status, Error Code and Satellite Vehicle Numbers	User's Guide
i	69	Print Position	User's Guide
j	6A	Clear Event Data (See Note 1)	Opt. Des. 04, 05
k	6B	Print Event Data (See Note 1)	Opt. Des. 04, 05
l	6C	Enable Event Log (See Note 1)	Opt. Des. 04, 05
m	6D	Disable Event Log (See Note 1)	Opt. Des. 04, 05
o	6F	Preset Coincidence (See Note 2)	Opt. Des. 09
p	70	Request Single Event (See Note 1)	Opt. Des. 04, 05
q	71	Request Ephemeris Data	User's Guide
r	72	Select Mode	User's Guide
s	73	Enable Time Interval	User's Guide
t	74	Disable Time Interval	User's Guide
u	75	Request Time Interval	User's Guide
x	78	Request Mask Levels	User's Guide
y	79	Enter Mask Levels	User's Guide
z	7A	Enable Discipline	User's Guide
{	7B	Disable Discipline	User's Guide
}	7D	Enter Position	User's Guide
~	7E	Enter DAC Value	User's Guide
DEL	7F	Request DAC Value	User's Guide
P	50	Select Output Code	User's Guide
Q	51	Enter Number of Position Averages	User's Guide
R	52	Enter Local Time Offset (1 Hour)	User's Guide
	7C	Enter Local Time Offset (1/2 Hour)	User's Guide
S	53	Select Satellite Vehicle Number (for Single Satellite Mode)	User's Guide
T	54	Enter Cable Delay	User's Guide
U	55	Request Cable Delay	User's Guide
V	56	Enter PDOP Limit	User's Guide
W	57	Resynchronize Minor Time	User's Guide
X	58	Select Default Values	User's Guide

Table Two Continued
Applicable Command/Character ID

ASCII Char	HEX Char	Description	Format/Response
Z	5A	Enable/Disable External Frequency Measurement (See Note 4)	Opt. Des. 02
[5B	Request External Frequency Measurement Data (See Note 4)	Opt. Des. 02
]	5D	Request Satellite Signal Strength	User's Guide
^	5E	Request Unit Operating Parameters	User's Guide
A	41	Request External 50/60 Hz Measurement Data (See Note 3)	Opt. Des. 08AE
B	42	Set-up External 50/60 Hz Measurement (See Note 3)	Opt. Des. 08AE
C	43	Enter IEEE-488 Address	This Opt. Des.

Note 1: Single or Triple Event Log Option, Option 04 or 05 must be installed.
See GPS Option Description 04 or 05.

Note 2: Preset Coincidence, Option 09 must be installed. See GPS Option Description 09.

Note 3: 115VAC/125VDC Power Supply with 50/60Hz Measurement Option, Option 08AE must be installed. See GPS Option Description 08AE.

Note 4: External Frequency Measurement Option, Option 02 must be installed.
See GPS Option Description 02.

ASSEMBLY 55115

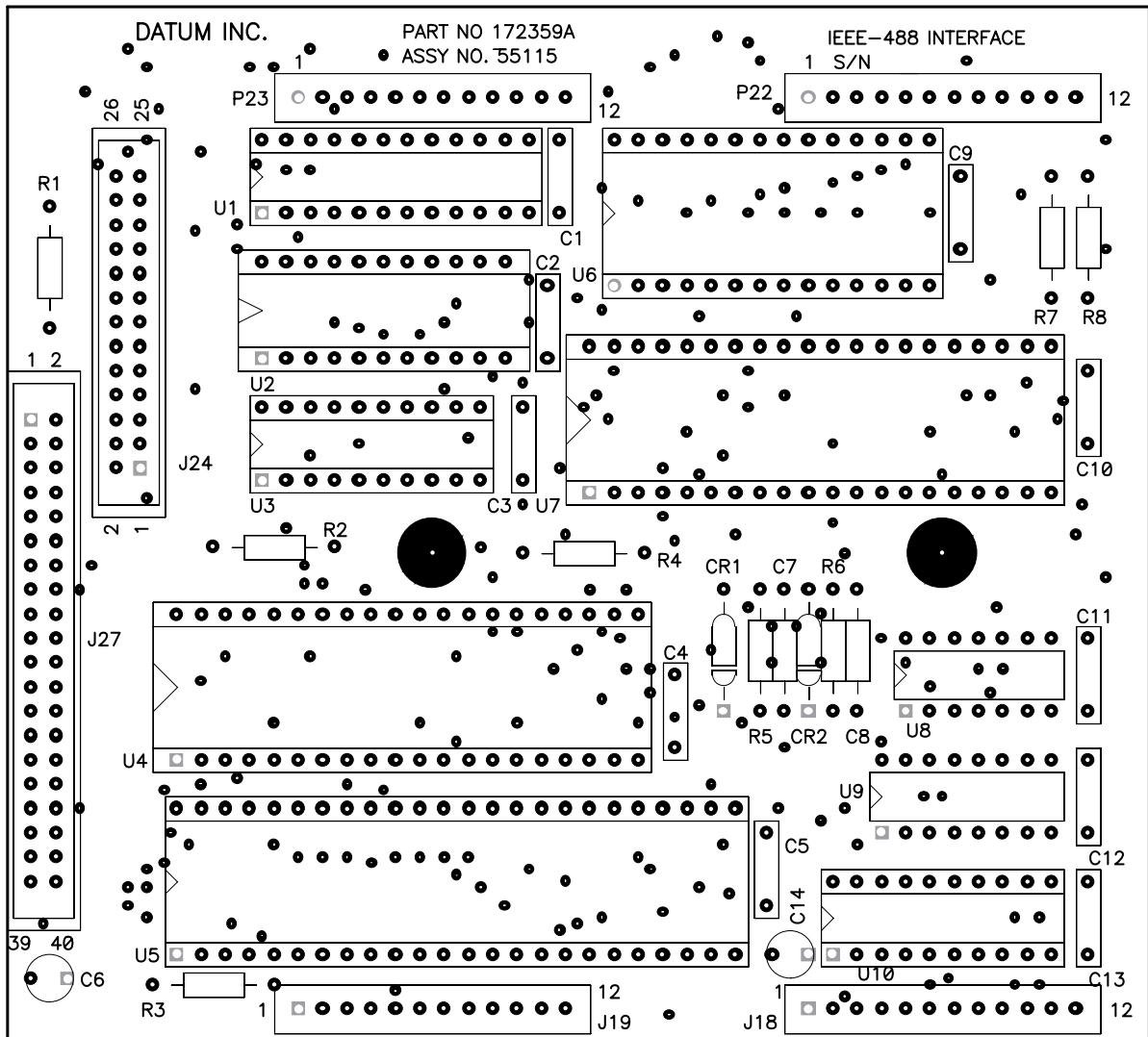

GPS OPTION 15A / GPS OPTION 15P 10 MHZ OSCILLATOR

RUBIDIUM TIME BASE MODEL LPRO

1.0 INTRODUCTION

These options provide an internal, disciplined 10MHz Rubidium Oscillator as the unit's time base. This 10MHz time base is frequency corrected using a DAC (Digital to Analog Converter) and locked to the GPS corrected 1PPS.

GPS Option 15P is identical to 15A except that 15P includes the 812515-19, Cable Assembly, which goes between J2 of the 55189 Power Entry and Alarm Relays Assembly and J1A of the 24 Volt Power Supply, providing an AC input to this supply. Cable Assembly 812503-12, which is used to interface between J20 of the 35002 GPS Main Assembly and J1 of the 55189 Power Entry and Alarm Relays Assembly is also provided.

The signal connections provided between J20 of the GPS Main Assembly and J2 of the 55189 Power Entry and Alarm Relays Assembly are as follows:

J20 PIN	J2 PIN	SIGNAL
1	1	LOCK\
2	2	TRK\
3	3	OUT5
4	4	OUT6
5	5	PD0
6	6	EXTFRE Q
7	7	PD7
8	8	VDD (+5)
9	9	PD6
10	10	GND

1.1 SPECIFICATIONS

Output Frequency/ Waveform:	10MHz sine wave
Output Amplitude:	1.0 VRMS into 50Ω
Aging Rate:	$\leq 5 \times 10^{-11}$ per month 5×10^{-10} per year
Operating Temperature:	-20°C Base Plate to +70°C Base Plate
Storage Temperature:	-55°C to +85°C
Altitude:	-200 feet to +20,000 feet
Trim Range:	$\geq \pm 1 \times 10^{-9}$

External Frequency Control: $\leq -1 \times 10^{-9}$ at 0V
 (Electrical): $\geq +1 \times 10^{-9}$ at +5V

The following specifications apply to the Selected 10 MHz Output at a 13dbm output level:

Harmonics:	-37 dBc
Spurious Noise:	>-70 dBc
Phase Noise:	
1Hz	-76 dBc/Hz
10Hz	-91 dBc/Hz
100Hz	-131 dBc/Hz
1KHz	-144 dBc/Hz
10KHz	-146 dBc/Hz

It is recommended that the oscillator be nulled when the DAC value starts to approach either extreme of 5,000 or 60,000. There is a hole on top of the oscillator for the oscillator adjustment control.

There are two methods to null/calibrate the internal oscillator.

FIRST METHOD

The oscillator can be nulled against a known frequency standard with an oscilloscope or other suitable means by using the following steps:

1. Turn on the unit and wait approximately one hour for the oscillator to warm up and stabilize.
2. Sync one trace of an oscilloscope on the known frequency standard. Using the other trace, monitor the 10MHz output of the unit.
3. The input of the DAC must be held static prior to the nulling oscillator. This can be accomplished one of three ways:
 - Disconnect the antenna from the rear of the unit.
 - Select the single satellite mode (1SV), and select a satellite that is not in view (or Pick SV33 which doesn't exist).
 - Disable disciplining. Refer to Chapter Four, "Disable Disciplining" in the User's Guide.
4. Set the DAC value to it's midpoint 32767. Refer to Chapter Four, "Enter DAC Value" in the User's Guide.

APPENDIX C

5. Adjust the oscillator until the 10MHz output is stable with respect to the frequency standard.
6. Enable disciplining. Refer to Chapter Four, “Enable Disciplining” in the User’s Guide.
7. After approximately one hour, check the DAC value number again. If it has changed by more than ± 5000 from 32767, repeat steps two through six.

SECOND METHOD

If a known frequency standard is not available, the oscillator may be null as follows:

1. Set the unit to operate in the single satellite (1SV) mode. Make sure the unit is tracking a satellite.
2. Read the DAC value either from the RS-232 I/O port, or from the LCD display.
3. The oscillator is located in front of the GPS Main Board on the Chassis Assembly.
4. SLOWLY (no more than 45° each time) adjust the oscillator and watch the DAC value change. If the DAC value is 65535, turn the oscillator adjustment counterclockwise, which will decrease the frequency and the DAC value. If the DAC value is 00000, turn the oscillator adjustment clockwise, which will increase the frequency and the DAC value.
5. Wait approximately one minute between each adjustment to allow the oscillator to stabilize.
6. Keep adjusting the oscillator in the appropriate direction until the DAC value is approximately at its midpoint (32767).
7. If after approximately one hour, the DAC value has changed by more than $\pm 5,000$ from 32767, repeat steps one through six.

**GPS OPTION 15C
10 MHZ OSCILLATOR**

**RUBIDIUM TIME BASE
MODEL X72**

1.0 INTRODUCTION

This option provides an internal, disciplined 10MHz Rubidium Oscillator as the unit's time base. This 10MHz time base is frequency corrected using a serial interface between the X72 and the GPS Main board (100015), and locked to the GPS corrected 1PPS.

The signal connections provided between the X72 connector and connector J23 on the GPS Main board are as follows:

J23 PIN	SIGNAL
1	VDD (Power Input)
2	VDD
3	VDD
4	VDD
5	VDD
6	VDD
7	VDD
8	SERVICE
9	DOUT
10	DIN
11	FREQ CTRL
12	VSS (Power and Signal Return)
13	VSS
14	VSS
15	VSS
16	VSS
17	VSS
18	VSS
19	1PPS IN
20	1PPS OUT
21	LOCK (if low, Rb oscillator locked)
22	FXQ (VCXO freq. output)
23	FACMOS RTN
24	FACMOS OUT
25	FSINE RTN
26	FSINE OUT

APPENDIX C

1.1 SPECIFICATIONS

Output Frequency/ Waveform: 10MHz sine wave

Output Amplitude: 7.8 dBm into 50Ω

Aging Rate:

APPLICATION PROFILE	AGING	TEMP. COEFFICIENT
AP1	$\leq 5 \times 10^{-11}$ per month	$\leq 1 \times 10^{-10}$ (-40°C to +85°C)
AP2	$\leq 3 \times 10^{-11}$ per day or $\leq 2 \times 10^{-10}$ per month	$\leq 2 \times 10^{-10}$ (0°C to +70°C)
AP3	$\leq 5 \times 10^{-8}$ over 20 years	(-40°C to +85°C)

Operating Temperature: -40°C Base Plate to +85°C Base Plate

Storage Temperature: -55°C to +100°C

Supply Voltage: +5VDC \pm 10%

Warm-up Time: 5 minutes to lock (accuracy @ lock $\leq 5 \times 10^{-8}$)

7.5 minutes (accuracy $\leq 1 \times 10^{-9}$)

The following specifications apply to the Selected 10 MHz Output (from the ET6000 etc.) at a 13dbm output level:

Harmonics: -37 dBc

Spurious Noise: >-70 dBc

Phase Noise:

1Hz -76 dBc/Hz

10Hz -91 dBc/Hz

100Hz -131 dBc/Hz

1KHz -144 dBc/Hz

10KHz -146 dBc/Hz

No mechanical calibration adjustment is required (or available).

GPS OPTION 21A

**10 MHZ SINE WAVE SHAPER
ASSEMBLY 20457-45**

1.0 INTRODUCTION

This Option Description provides specifications, an explanation of the Sine Wave Shaper logic used to develop the Sine Wave output and adjustment of the output amplitude.

This Shaper Assembly can be plugged into the J7/J9, J8/J10, J18/J22, or J19/J23 area of the 35007 Motherboard Assembly. The 10MHz Sine Wave output will be present on the rear panel BNC, J3A, J3B, J3D, or J3E respectively.

1.1 SPECIFICATIONS

The following specifications apply at 13dbm output level using an oven oscillator. These specifications are worst case.

Harmonics:	-35 dBc
Spurious Noise:	-35 dBc
Phase Noise:	
1Hz	-72 dBc/Hz
10Hz	-94 dBc/Hz
100Hz	-112 dBc/Hz
1KHz	-115 dBc/Hz
10KHz	-117 dBc/Hz
100KHz	-121 dBc/Hz

1.2 FUNCTIONAL EXPLANATION

A 10MHz square wave derived from the 10MHz internal oscillator is input to J1 pin 9 of the Sine Wave Shaper Assembly. The signal is filtered and shaped to generate the 10MHz Sine Wave output at P1 pin 2 of the same assembly.

This signal is then routed to a rear panel BNC. Refer to the GPS Option/Connector Configuration sheet in the User’s Guide for the output connector designation. Refer to the Top Assembly Drawing for connector location. This signal is adjustable from zero to six volts peak-to-peak and has been factory adjusted to three volts peak-to-peak into a 50Ω load.

1.3 OUTPUT AMPLITUDE ADJUSTMENT

The output amplitude of this signal can be adjusted to the desired amplitude using LEVEL potentiometer R13, on the Sine Wave Shaper assembly.

GPS OPTION 23A/23B**LIGHTNING ARRESTOR
W/25 OR 50 FOOT ANTENNA CABLE****1.0 INTRODUCTION**

This option provides protection of the GPS unit from external over-voltage transients which can be created through lightning, static discharges, switch processes, direct contact with power lines, or through earth currents.

The lightning and nuclear EMP arrestors limit the amplitude and duration of the disturbing interference voltages. Therefore these arrestors improve the over-voltage resistance of in-line equipment, systems and components.

Note: The antenna cable described in this manual has been replaced as described in “Appendix D: Antenna Replacement Kit” on page D-1.

The 23A option comes with a twenty-five foot length of 9913 Antenna Cable and the 23B option comes with a fifty foot length of 9913 Antenna Cable. Both cables have Type N positive connectors on each end.

This Option may require that the GPS unit to which it is connected have a Bias T Assembly installed externally. This assembly would furnish a separate +5 volts to power the antenna. See the Bias T installation procedure furnished with the Bias T.

1.1 SPECIFICATIONS FOR THE 9913 LOW LOSS COAXIAL ANTENNA CABLE

Cable Diameter	0.45 Inches
Center Conductor	10 (Solid) .108 Stranded Copper .90 Ω per 1000 ft.
Shield	90% Tinned Copper Braid.
Attenuation	Nominal 5.6 dB per 100 ft at 1.5GHz.
Cable Jacket	Black PVC

1.2 SPECIFICATIONS FOR THE LIGHTNING ARRESTOR

Frequency Range	1565 to 1586 MHz
Return Loss	> 20dB from 1565 to 1586 MHz
Insertion Loss	< 0.5 dB from 1565 to 1585 MHz
Impedance	50 Ω
Connector	Type N

Environment:	-40°C to +85°C
Sealing:	Waterproof IP66 Standard (Mil, etc.)
Bypass Voltage:	6 Volt Max. with Gas Insert.
Bypass Current:	1 Amp
DC Resistance:	< 1 Ω
Length:	4.53 Inches
Width:	1.36 Inches.
Depth:	2.6 Inches Not Including Type N Connectors.

1.3 LIGHTNING ARRESTOR INSTALLATION

The following installation procedure balances the voltage potential thus preventing inductive interference to parallel signal lines within the protected area.

- Mount the Lightning Arrestor on a metal mounting plate or bar (customer furnished) with a thickness not to exceed 0.33 inches. See Figure One.
- The Lightning Arrestor should be mounted so that the mounting plate and the Lightning Arrestor are outside of the enclosure where the GPS unit is housed.
- The Lightning Arrestor should be placed on the unprotected side.
- The connection between the mounting plate and the ground terminal should be accomplished with a low resistance path such as a copper strap (customer furnished).
- The contact surface of the mounting plate must be conductive (free of any paint, anodization or oxides). Tighten the mounting nut to reduce the contact resistance between the arrestor body and the mounting plate.
- Connect an AWG 5 or larger wire between the ground terminal on the mounting plate to a good earth ground. Remove the gas capsule arrestor access cover and insert the gas arrestor capsule into the lightning arrestor body and tighten the capsule holder to a minimum torque of 4.43 foot pounds.
- When connecting the cable from the antenna to the Lightning Arrestor, install a drip loop before it enters the arrestor. This keeps any large amounts of moisture from coming down the cable and collecting at the connector, causing a loss and/or failure.

APPENDIX C

- Both inside and outside, secure the cable as close as possible to the arrester. This relieves strain on the N connectors and the arrester.

*** * * WARNING * * ***

Please adhere to the following recommendations to prevent accidents during the installation of the Lightning Arrester:

Disconnect or switch off in-line equipment when installing or inspecting the Lightning Arrester. Also, do not install or inspect the Lightning Arrester during an electrical storm.

When connecting the Lightning Arrester or when changing the gas capsule arrester, make sure that the connecting equipment and components are disconnected or switched off.

Figure One
Lightning Arrestor Mounting

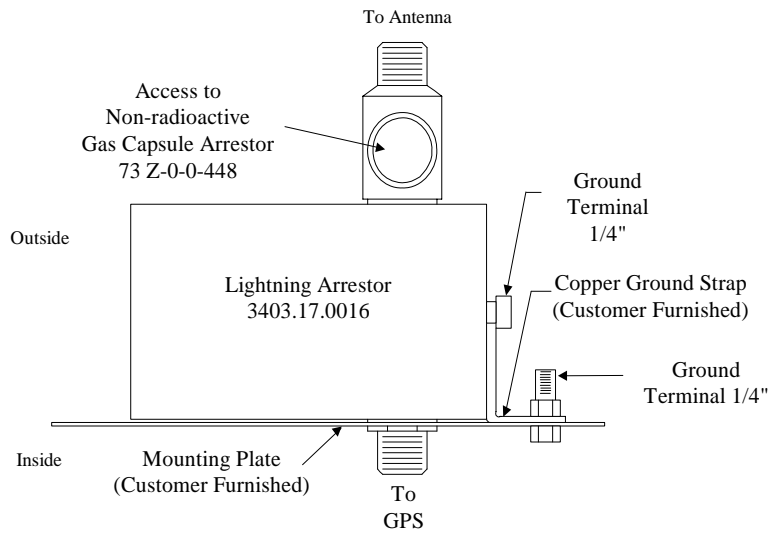

**Figure Two
Lightning Arrestor Mounting
Dimensions**

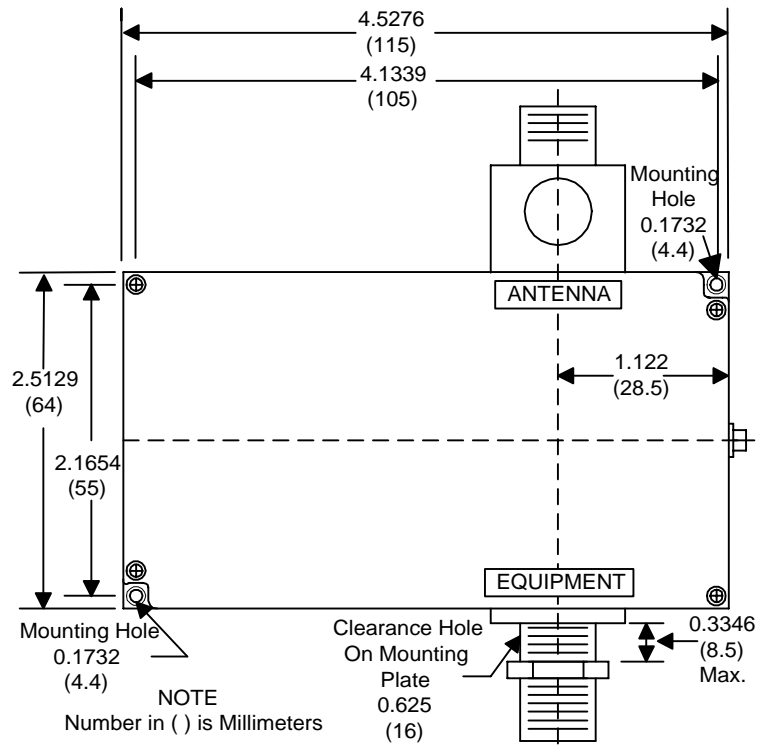

GPS OPTION 27A/B/C/D

**SIGNAL DISTRIBUTION
ASSEMBLY 55143**

1.0 INTRODUCTION

This option, in conjunction with various plug-in modules provides up to twelve independently buffered signal outputs. The types of signals and signal characteristics are dependent on the buffer modules and the input to the module. This input is jumper selectable and located underneath each module.

1.1 CONFIGURATION

The module sockets are labeled U1 through U12. On the left side of the card edge are twelve output connectors, J1-J12. J1 corresponds to socket U1, etc. The 14 pin jumper arrangement inside each socket selects the input to the plug-in module. Various modules are available to provide analog and digital buffered outputs. Rear panel output connector designations and signal characteristics are described in the GPS Option/Connector Configuration sheet located at the front of the ExacTime User’s Guide. The type of module plugged into each socket depends on the jumper selected input. Analog buffers can output both digital and analog signals. For digital signals requiring specific pulse widths and on-time edges, digital buffers are required.

The typical module input selection for U1 is as follows:

U1A-1 to U1A-28	1MHz Square Wave
U1A-2 to U1A-27	Out 1
U1A-3 to U1A-26	5MHz Square Wave
U1A-4 to U1A-25	Out 2
U1A-5 to U1A-24	10MHz Square Wave
U1A-6 to U1A-23	1pps
U1A-7 to U1A-22	AC Modulated Code
U1A-8 to U1A-21	DC Level Shift Code
U1A-9 to U1A-20	Locked
U1A-10 to U1A-19	PD7
U1A-11 to U1A-18	PD6
U1A-12 to U1A-17	Spare 1
U1A-13 to U1A-16	Spare 2
U1A-14 to U1A-15	Spare 3

All other modules input selection is similar. Out1, Out 2, Spare 1, Spare 2, and Spare 3 can be optionally jumpered to other signals dependent on customer requirements. PD6 and PD7 are software controlled optional signals.

1.2 GPS Option 27A - Output Connections - Assembly 55143

Pin 1 and Pin 2 of connectors J1 through J12 are the signal and the ground return pins, respectively, for Options 27B and 27D.

Pin 1 and Pin 2 of connectors J1 through J12 are the “signal hi” and the “signal lo” pins respectively for Option 27C.

Pin 1 of connector J1 through J12 is the uppermost pin and Pin 2 is the pin nearest to the PC board.

1.3 GPS Option 27B - Analog Buffer - 50Ω Driver - Assembly 35001

This analog buffer plug in module is a gain of one amplifier capable of driving 50Ω. The output amplitude is dependent on the input amplitude. Its frequency response is from DC to 10MHz.

1.4 GPS Option 27C - RS-422 Differential Buffer - Assembly 35028

This RS-422 buffer plug in module is a differential line driver with output levels of 0 to +5 volts. It is a line driver for digital data transmission over balanced lines. It is designed to provide unipolar differential drive to twisted-pair or parallel-wire transmission lines.

1.5 GPS Option 27D - Pulse Buffer - Assembly 35000

This pulse buffer plug in module outputs a 0 to +10 volt positive going signal. Dash numbers determine the input on-time edge selection and pulse width.

Example:

35000-110	Triggers on input negative/falling edge. 20μs pulse width.
35000-210	Triggers on input positive/rising edge. 20μs pulse width.

ASSEMBLY 55143

NEAR SIDE OF P.C. BOARD SHOWN

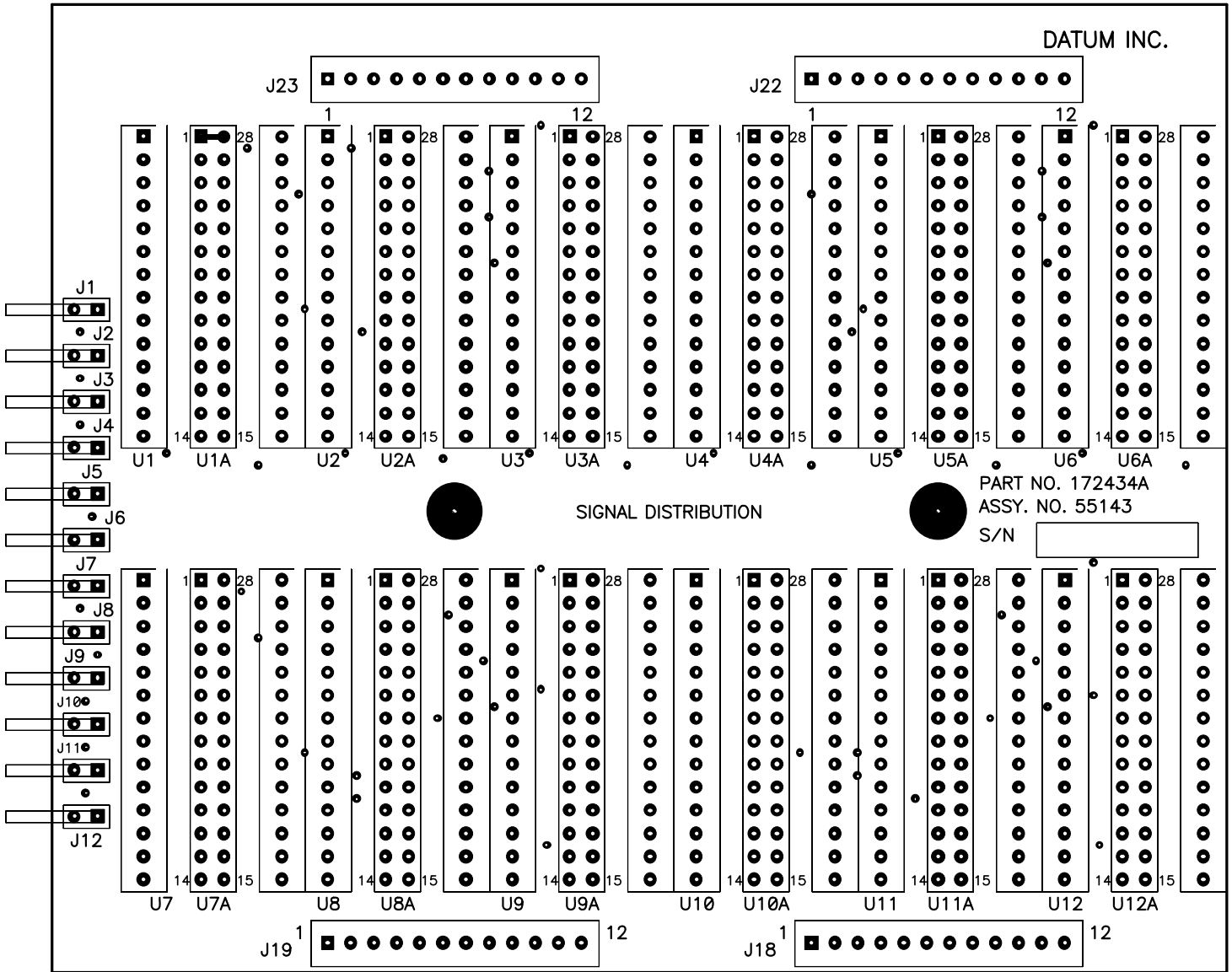

GPS OPTION 33A

**1.544/2.048 MHZ SQUARE WAVE OUTPUT
ASSEMBLY 55138**

1.0 INTRODUCTION

The 1.544/2.048MHz Output Assembly 55138 provides a 1.544MHz T1 square wave clock or a 2.048MHz E1 square wave clock (switch selectable).

1.1 CONFIGURATION

It is a single width assembly that is mounted on the GPS Motherboard (GPS Option 40). The Motherboard provides support for this assembly, an interface to the GPS Main Assembly, and interface to the rear panel output BNC's.

The Motherboard has four (4) single width option areas. Where the 1.544/2.048 Output Assembly is installed determines the rear panel output BNC.

The following is the correlation between the option area and the output:

Option Area	Rear Panel BNC
J7/J9	J3B
J8/J10	J3C
J18/J22	J3E
J19/J23	J3F

The buffered output can provide TTL levels into 50Ω.

1.2 OPTIONAL FEATURES

The following features are switch selectable:

- S1 open/up Selects T1 1.544MHz output
- S1 closed/down Selects E1 2.048MHz output

- S2 open/up Allows the square wave to be synchronized to 1PPS. This is a factory test position only.
- S2 closed/down Prohibits the square wave from being synchronized.

- S3 closed/down The square wave is output only while the unit is in the LOCK mode
- S3 open/up The square wave will be output regardless of whether the unit is locked or not.

GPS OPTION 33B

**T1 FRAMED ONES – BALANCED OUTPUT
ASSEMBLY 55155**

GPS OPTION 33C

**E1 FRAMED ONES – BALANCED OUTPUT
ASSEMBLY 55155-1**

1.0 INTRODUCTION

This optional assembly (Option 33B - T1 or Option 33C - E1) uses a DS1 (or a CEPT) Telecommunications Synthesizer and can serve as a stand alone Stratum 1 Master Clock when installed in an instrument that has a Rubidium Oscillator as its time base. Or it can be a component of a master clock system. This assembly can be installed in locations J7/J9 J8/J10 or J18/J22 J19/J23 of the GPS Option 40 Motherboard Assembly. For the location of the 55155 (or 55155-1) Assembly and the rear panel output connector designations, characteristics, and locations, refer to the GPS Option/Connector Configuration Sheet located inside the cover of the ExacTime User’s Guide.

For a more in-depth description of T1 and/or E1 and the options provided on this assembly, refer to the following:

- CCITT Standards G.704, G.706, and G.732.
- Also ATT pub 43801, ATT C.B. #142, and ATT C.B. #144.

1.1 GENERAL DESCRIPTION – GENERATION OF T1 (1.544MHz)

- Assembly 55155 generates the T1 (1.544MHz) framed all ones, DS1 signal. It provides the following output to the rear panel of this instrument. The connector pin assignments are:

Pin	Signal
1	Balanced 1.544MHz framed all ones, DS1 Hi.
2	Balanced 1.544MHz framed all ones, DS1 Lo.
3	Output Transformer Center Tap.

Adding a jumper from E3 to E4 on the 55155 assembly allows the transformer center tap to be grounded.

The output is frequency locked to an internal 10MHz reference.

The DS1 signal is switch selectable to provide various features. (See Table One below).

- Down is the closed (0) position.
- Up is the open (1) position.
- Switch 1-1 selects between T1 and E1 functions.

TABLE ONE

Switch	Closed (0)	Open (1)
1-1	Selects E1	*Selects T1
1-2	*Inhibits 1pps Sync	Enables 1pps Sync
1-3	*Allows framed output during alarms.	Inhibits framed output during alarms.
2-1	N/A	N/A
2-2	*ABCD Data = Zero	ABCD Data = One
2-3	*Transmit Link Data Zeros	Transmit Link Data Ones
2-4	*Internally Generate S Bit	Insert transmit link data into S bit.
2-5	*Mode 193S	Mode 193E
2-6	*Disabled	Transmit Yellow Alarm
3-1	*T1 Output	E1 Output
3-2	See Table Two below.	
3-3	See Table Two below.	
3-4	See Table Two below.	
3-5	*Inhibit Bit 7 Stuffing.	Enable Bit 7 Stuffing.
3-6	Inhibit B8ZS	Enable B8ZS

* The normal, as shipped position of each switch.

**TABLE TWO
LINE LENGTH SELECTION**

SW3-4	SW3-3	SW3-2	Option Selected	Application
0	0	0	Test Mode	Do Not Use
0	0	1	-7.5 dB Build-out	T1 CSU
0	1	0	-15 dB Build-out	T1 CSU
*0	*1	*1	0 dB Build-out 0-133 feet	T1 CSU, DSX-1 Cross Connect
1	0	0	133 - 266 Feet	DSX - 1 Cross Connect
1	0	1	266 - 399 Feet	DSX - 1 Cross Connect
1	1	0	399 - 533 Feet	DSX - Cross Connect
1	1	1	533 - 655 Feet	DSX - Cross Connect

* The normal, as shipped position of each switch.

Table Three is a list of specifications applicable to GPS Option 33B (T1 Assembly 55155)

**TABLE THREE
SPECIFICATIONS, 55155**

Outputs		
DS1	Signal Type	DS1, Balanced
	Frequency	1.544 MHz
	Format	Framed All 1's (D4 or ESF)
	Jitter	<0.05 U.I.
	Connector	See Note

Note: See the GPS Option/Connector Configuration Sheet in the ExacTime User's Guide.

**Figure One
D4 and Extended Superframe Formats**

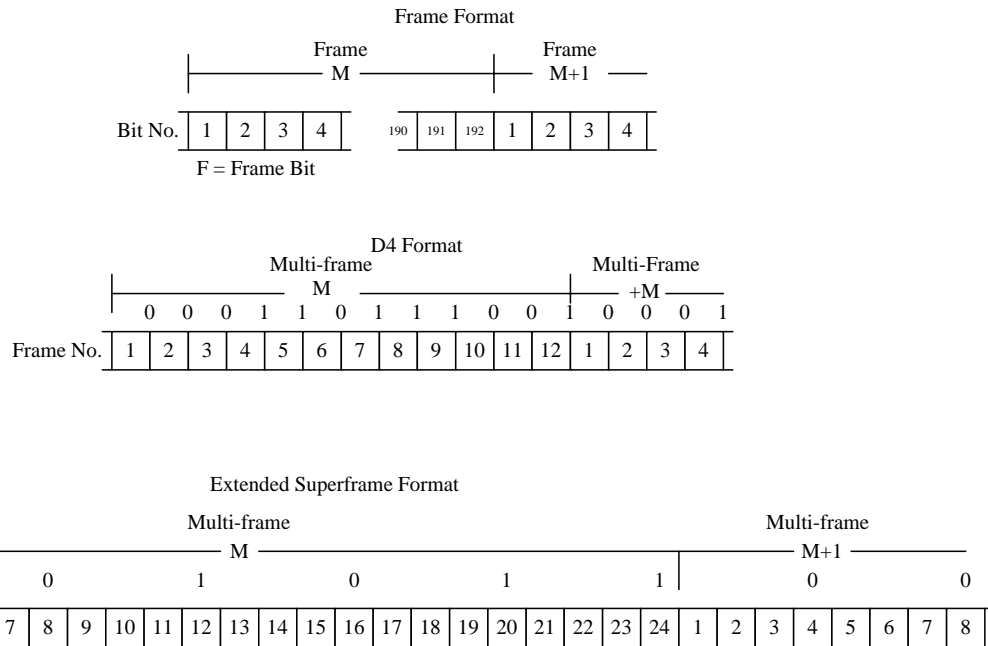

FDL bits are all zeros. Appropriate CRC check sums are generated.

APPENDIX C

1.2 GENERAL DESCRIPTION – GENERATION OF E1 (2.048MHz)

- Assembly 55155-1 generates the E1 (2.048MHz) CEPT signal and associated outputs. It provides the following output to the rear panel of this instrument. The connector pin assignments are as follows:

Pin	Signal
1	Balanced 2.048MHz framed all ones, CEPT Hi.
2	Balanced 2.048MHz framed all ones, CEPT Lo.
3	Output Transformer Center Tap.

Adding a jumper from E3 to E4 on the 55155 assembly allows the transformer center tap to be grounded.

The output is frequency locked to an internal 10MHz reference.

The CEPT signal is switch selectable to provide various features. (See Table Four).

- Down is the closed (0) position.
- Up is the open (1) position.
- Switch 1-1 selects between T1 and E1 functions.

TABLE FOUR

Switch	Closed (0)	Open (1)
1-1	*Selects E1	Selects T1
1-2	*Inhibits 1pps Sync	Enables 1pps Sync
1-3	*Allows framed output during alarms.	Inhibits framed output during alarms.
2-1	Transmit Extra Data Zeros	*Transmit Extra Data Ones
2-2	CAS Signaling Zero	*CAS Signaling One
2-3	Transmit National/International Zero	Transmit National/International One
2-4	*Disable Remote Alarm	Enable Remote Alarm
2-5	*Disable Distant Multi-Frame Alarm	Enable Distant Multi-Frame Alarm
2-6	*AMI Coding	HDB3 Coding
3-1	T1 Output	*E1 Output
3-2		*
3-3		*
3-4		*
3-5	*Disable CRC4 Multi-frame	Enable CRC4 Multi-frame
3-6	Enable CAS Multi-frame	*Disable CAS Multi-frame

* The normal, as shipped position of each switch.

Figure Two
Time Slot, Frame, and CEPT Formats

Time Slot Format (8 Bits/Time Slot)

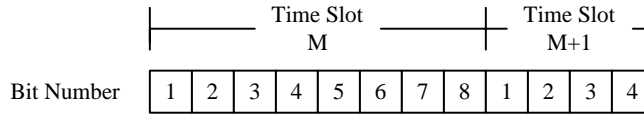

Frame Format (Thirty-Two Time Slots/Frame)

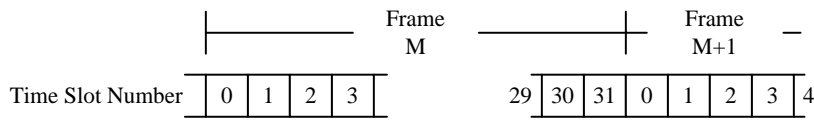

CEPT Format (Sixteen Frames/Multi-Frame)

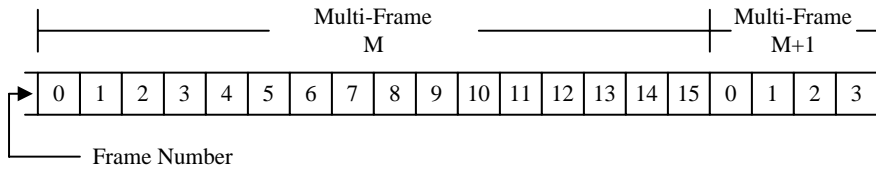

Table Five is a list of specifications applicable to GPS Option 33C (E1 Assembly 55155-1).

**TABLE FIVE
SPECIFICATIONS, 55155-1**

Outputs		
CEPT	Signal Type	CEPT, Balanced
	Frequency	2.048 MHz
	Format	Framed All 1's
	Jitter	<0.05 U.I.
	Connector	See Note

Note: See the GPS Option/Connector Sheet in the ExacTime User's Guide.

ASSEMBLY 55155

NEAR SIDE OF P.C. BOARD SHOWN.

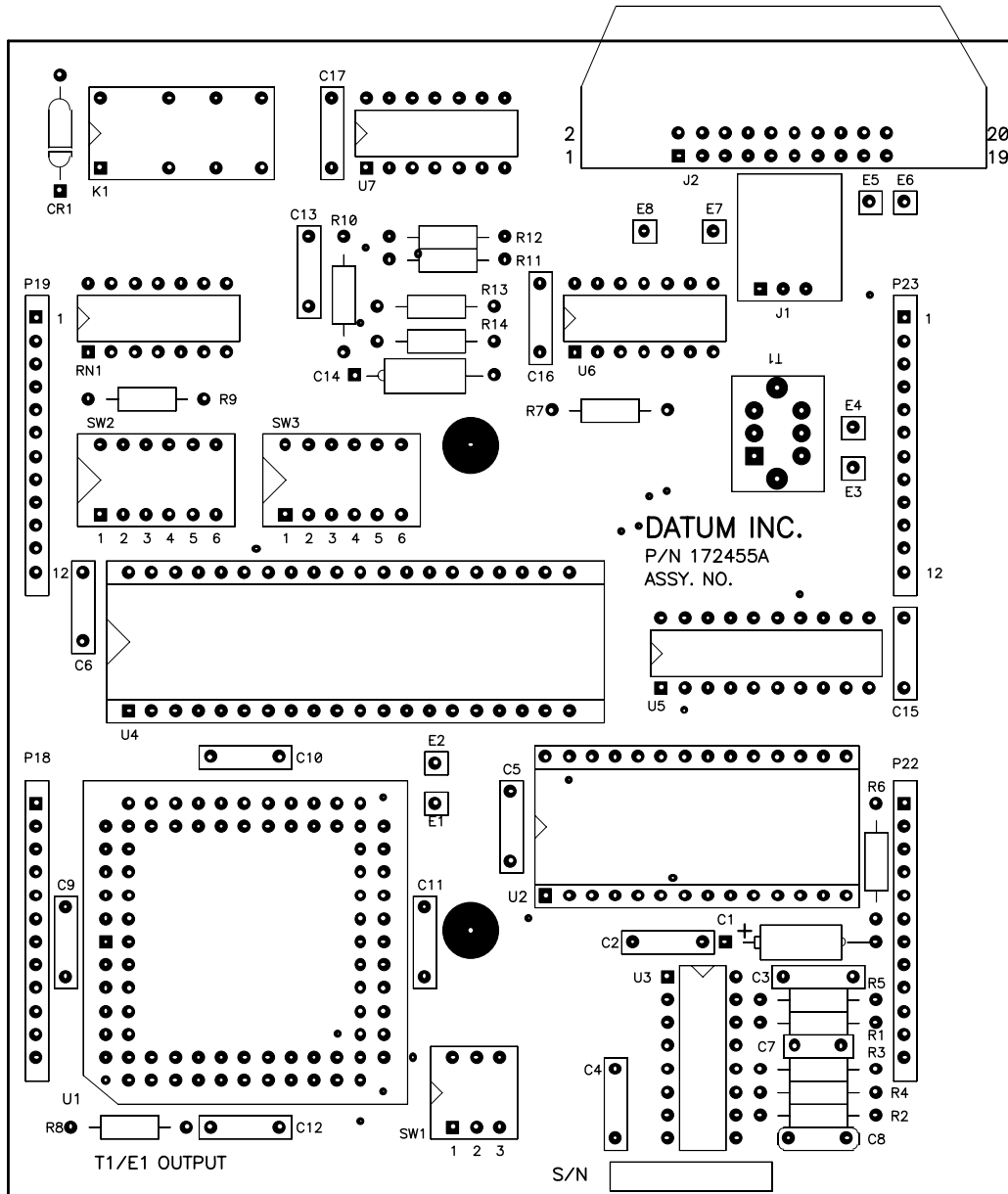

GPS OPTION 33D

**T1 FRAMED ONES - BALANCED OUTPUT
ASSEMBLY 55155-2**

GPS OPTION 33E

**E1 FRAMED ONES - BALANCED OUTPUT
ASSEMBLY 55155-12**

1.0 INTRODUCTION

This optional assembly (Option 33D - T1 or Option 33E - E1) uses a DS1 (or a CEPT) Telecommunications Synthesizer and can serve as a stand alone Stratum 1 Master Clock when installed in an instrument that has a Rubidium Oscillator as its time base. Or it can be a component of a master clock system. This assembly can be installed in locations J7/J9 J8/J10 or J18/J22 J19/J23 of the GPS Option 40 Motherboard Assembly. For the location of the 55155-2 (or 55155-12) Assembly and the rear panel output connector designations, characteristics, and locations, refer to the GPS Option/Connector Configuration Sheet located inside the cover of the ExacTime User's Guide.

For a more in-depth description of T1 and/or E1 and the options provided on this assembly, refer to the following:

- CCITT Standards G.704, G.706, and G.732.
- Also ATT pub 43801, ATT C.B. #142, and ATT C.B. #144.

1.1 GENERAL DESCRIPTION – GENERATION OF T1 (1.544MHz)

- Assembly 55155-2 generates the T1 (1.544MHz) framed all ones, DS1 signal and associated outputs. It provides the following input/outputs on a rear panel (20) pin connector. The connector pin assignments are as follows:

Pin	Signal
1	Balanced 1.544MHz framed all ones, DS1 Hi.
2	Aux. Alarm Relay Common Contact.
3	Balanced 1.544 MHz framed all ones, DS1 Hi.
4	Aux. Alarm Relay Normally Closed Contact.
5	Output Transformer Center Tap.
6	Aux. Alarm Relay Normally Open Contact.
7	Alarm Relay Normally Open Contact.
8	Alarm Relay Common Contact.
9	Alarm Relay Normally Closed Contact.
10	Not Used.
11	SYNC Input.
12	Sync Input Return.
13	8kHz TTL Output.
14	GND.
15	1.544MHz TTL Clock Output

APPENDIX C

16	GND.
17	Not Used.
18	Not Used.
19	Not Used.
20	Not Used.

SYNC input allows the DS1 and Frame Alignment outputs to be synchronized to an external reference of 8kHz or sub-multiple of 8kHz.

Alarm relay closure is a summary alarm closure.

Adding a jumper from E3 to E4 on the 55155-2 assembly allows the transformer center tap to be grounded.

All of these optional outputs are frequency locked to an internal 10MHz reference.

The DS1 signal is switch selectable to provide various features. (See Table One below).

- Down is the closed (0) position.
- Up is the open (1) position.
- Switch 1-1 selects between T1 and E1 functions.

TABLE ONE

Switch	Closed (0)	Open (1)
1-1	Selects E1	*Selects T1
1-2	*Inhibits 1pps Sync	Enables 1pps Sync
1-3	*Allows framed output during alarms.	Inhibits framed output during alarms.
2-1	N/A	N/A
2-2	*ABCD Data = Zero	ABCD Data = One
2-3	*Transmit Link Data Zeros	Transmit Link Data Ones
2-4	*Internally Generate S Bit	Insert transmit link data into S bit.
2-5	*Mode 193S	Mode 193E
2-6	*Disabled	Transmit Yellow Alarm
3-1	*T1 Output	E1 Output
3-2	See Table Two below.	
3-3	See Table Two below.	
3-4	See Table Two below.	
3-5	*Inhibit Bit 7 Stuffing.	Enable Bit 7 Stuffing.
3-6	Inhibit B8ZS	Enable B8ZS

* The normal, as shipped position of each switch.

**TABLE TWO
LINE LENGTH SELECTION**

SW3-4	SW3-3	SW3-2	Option Selected	Application
0	0	0	Test Mode	Do Not Use
0	0	1	-7.5 dB Build-out	T1 CSU
0	1	0	-15 dB Build-out	T1 CSU
*0	*1	*1	0 dB Build-out 0-133 feet	T1 CSU, DSX-1 Cross Connect
1	0	0	133 - 266 Feet	DSX - 1 Cross Connect
1	0	1	266 - 399 Feet	DSX - 1 Cross Connect
1	1	0	399 - 533 Feet	DSX - Cross Connect
1	1	1	533 - 655 Feet	DSX - Cross Connect

* The normal, as shipped position of each switch.

Table Three is a list of specifications applicable to GPS Option 33D (T1 Assembly 55155-2)

**TABLE THREE
SPECIFICATIONS, 55155-2**

Outputs		
DS1	Signal Type Frequency Format Jitter Connector	DS1, Balanced 1.544 MHz Framed All 1's (D4 or ESF) <0.05 U.I. See Note
Frame Marker	Signal Type Frequency Connector	TTL 8 kHz See Note
TTL Clock	Signal Type Frequency Connector	TTL 1.544 MHz See Note
Inputs	Frame Synchronization Frequency Connector	TTL compatible, active low 8 kHz or sub-multiple of 8 kHz See Note
Monitor	Summary Alarm Contact Rating (maximum) Connector	Contact Closure 2 A at 30 V dc See Note

Note: See the GPS Option/Connector Configuration Sheet in the ExacTime User's Guide.

Figure One
D4 and Extended Superframe Formats

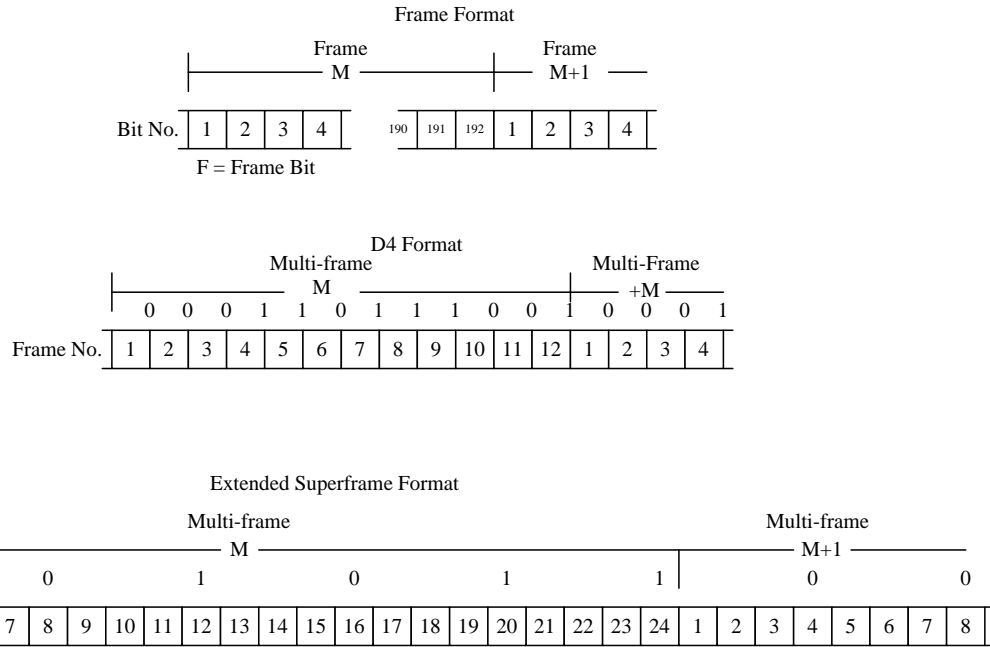

FDL bits are all zeros. Appropriate CRC check sums are generated.

1.2 GENERAL DESCRIPTION – GENERATION OF E1 (2.048 MHz)

- Assembly 55155-12 generates the E1 (2.048 MHz) CEPT signal and associated outputs. It provides the following input/outputs on a rear panel (20) pin connector. The connector pin assignments are as follows:

Pin	Signal
1	Balanced 2.048MHz framed all ones, CEPT Hi.
2	Aux. Alarm Relay Common Contact.
3	Balanced 2.048MHz framed all ones, CEPT Hi.
4	Aux. Alarm Relay Normally Closed Contact.
5	Output Transformer Center Tap.
6	Aux. Alarm Relay Normally Open Contact.
7	Alarm Relay Normally Open Contact.
8	Alarm Relay Common Contact.
9	Alarm Relay Normally Closed Contact.
10	Not Used.
11	SYNC Input.
12	SYNC Input Return (GND).
13	8kHz TTL Output.
14	GND.
15	2.048Mhz TTL Clock Output.
16	GND.
17	Not Used.
18	Not Used.
19	Not Used.
20	Not Used.

SYNC input allows the CEPT and frame alignment outputs to be synchronized to an external reference of 8kHz or sub-multiple of 8kHz.

Alarm relay closure is a summary alarm closure.

Adding a jumper from E3 to E4 on the 55155-12 assembly allows the transformer center tap to be grounded.

All three of these optional outputs are frequency locked to an internal 10MHz reference.

The CEPT signal is switch selectable to provide various features. (See Table Four).

- Down is the closed (0) position.
- Up is the open (1) position.

APPENDIX C

- Switch 1-1 selects between T1 and E1 functions.

TABLE FOUR

Switch	Closed (0)	Open (1)
1-1	*Selects E1	Selects T1
1-2	*Inhibits 1pps Sync	Enables 1pps Sync
1-3	*Allows framed output during alarms.	Inhibits framed output during alarms.
2-1	Transmit Extra Data Zeros	*Transmit Extra Data Ones
2-2	CAS Signaling Zero	*CAS Signaling One
2-3	Transmit National/International Zero	Transmit National/International One
2-4	*Disable Remote Alarm	Enable Remote Alarm
2-5	*Disable Distant Multi-Frame Alarm	Enable Distant Multi-Frame Alarm
2-6	*AMI Coding	HDB3 Coding
3-1	T1 Output	*E1 Output
3-2		*
3-3		*
3-4		*
3-5	*Disable CRC4 Multi-frame	Enable CRC4 Multi-frame
3-6	Enable CAS Multi-frame	*Disable CAS Multi-frame

* The normal, as shipped position of each switch.

**TABLE FIVE
SPECIFICATIONS, 55155-12**

Outputs		
CEPT	Signal Type Frequency Format Jitter Connector	CEPT, Balanced 2.048 MHz Framed All 1's <0.05 U.I. See Note
Frame Marker	Signal Type Frequency Connector	TTL 8 kHz See Note
TTL Clock	Signal Type Frequency Connector	TTL 1.544 MHz See Note
Inputs	Frame Synchronization Frequency Connector	TTL compatible, active low 8 kHz or sub-multiple of 8 kHz See Note
Monitor	Summary Alarm Contact Rating (maximum) Connector	Contact Closure 2 A at 30 V dc See Note

Note: See the GPS Option/Connector Configuration Sheet in the ExacTime User's Guide.

Figure Two
Time Slot, Frame, and CEPT Formats

Time Slot Format (8 Bits/Time Slot)

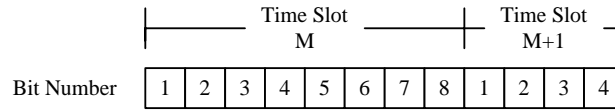

Frame Format (Thirty-Two Time Slots/Frame)

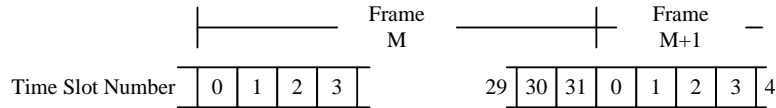

CEPT Format (Sixteen Frames/Multi-Frame)

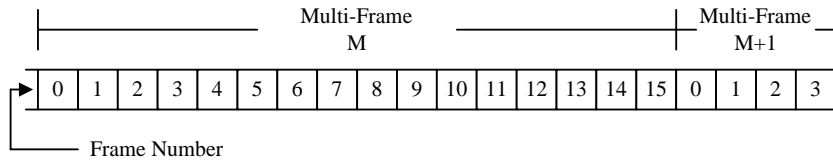

Note: For a top assembly view of this module, see the previous section

GPS OPTION 40

**GPS OPTION MOTHERBOARD
ASSEMBLY 35007
W/6 BNC OUTPUTS**

GPS OPTION 40P

1.0 INTRODUCTION

GPS Option 40 (Motherboard Assembly 35007) provides the expansion capability to add optional assemblies to the GPS Timing Unit. It provides a platform to support these assemblies and an interface between these assemblies and the GPS Main Assembly 35002.

The Motherboard Assembly can support two double width options or four single width options. Also, depending upon the options themselves and if space permits, some options can be stacked on top of other options.

The motherboard is also provided with a variety of rear panel butch plates and output connectors depending upon the options supplied.

GPS Option 40P is identical to 40 except that 40P includes the 812363-9 cable used to connect J2 of the 35007 Motherboard Assembly to J1 of the 55189 Power Entry and Alarm Relays Assembly. It provides the signal paths to and from the 55189 Assembly to the GPS Main Assembly 35002.

1.1 OPERATIONAL FEATURES

The basic Motherboard has four plug-in option areas J7/J9, J8/J10, J18/J22, and J19/J23. Each of these option areas provides one or two single-ended BNC outputs. However, depending upon the option installed, some of these outputs may or may not be used.

Rear Panel Output Connector designations and signal characteristics are described in the GPS Option/Connector Configuration sheet located at the front of the ExacTime User's Guide.

The following is the correlation between the option area and the output:

J7/J9 area	Rear panel BNC J3B, optional J3A.
J8/J10	Rear panel BNC J3C.
J18/J22	Rear panel BNC J3E, optional J3D.
J19/J23	Rear panel BNC J3F.

Each of the above outputs is provided via a 250 milliamperere high speed buffer/driver. The gain of the buffer is 1:1 so the output amplitude is dependent on the input and the load.

APPENDIX C

For GPS Option 40P, the signal connections provided at J2 of the 35007 Motherboard Assembly are as follows:

J2 PIN	SIGNAL
1	LOCK\
2	TRK\
3	OUT5
4	OUT6
5	PD0
6	EXTFREQ
7	PD7
8	VDD (+5)
9	PD6
10	GND

GPS OPTION 40A

**GPS OPTION MOTHERBOARD
ASSEMBLY 35007-1
W/1 BNC OUTPUT**

GPS OPTION 40AP

1.0 INTRODUCTION

GPS Option 40A (GPS Motherboard Assembly 35007-1) provides the expansion capability to add optional assemblies to the GPS Timing Unit. It provides a platform to support these assemblies and an interface between these assemblies and the GPS Main Assembly 35002.

The motherboard assembly can support two double width options or four single width options. Also, depending upon the options themselves, and if space permits, some options can be stacked on top of other options.

The motherboard is also provided with a variety of rear panel butch plates and output connectors depending upon the option supplied.

GPS Option 40AP is identical to 40A except that 40AP includes the 812363-9 cable used to connect J2 of the 35007 Motherboard Assembly to J1 of the 55189 Power Entry and Alarm Relays Assembly. It provides the signal paths to and from the 55189 Assembly to the GPS Main Assembly 35002.

1.1 OPERATIONAL FEATURES

The basic motherboard has four plug-in option areas, J7/J9, J8/J10, J18/J22, and J19/J23. Each of these option areas provides one or two single-ended BNC outputs. However, depending upon the option installed, some of these outputs may or may not be used.

In this particular configuration, the output connector(s) for the optional assembly plugged into the J8/J10 and J7/J9 areas of the motherboard require excessive rear panel space. This requires removing motherboard BNCs J3A through J3E. The only remaining option area with access to a rear panel BNC is J19/J23.

The following is the correlation between the option area and the output.

J19/J23	Rear Panel BNC J3F.
---------	---------------------

The above output is provided via a 250 milliamphere high speed buffer/driver. The gain of the buffer is 1:1 so the output amplitude is dependant upon the input and the load.

APPENDIX C

For GPS Option 40AP, the signal connections provided at J2 of the 35007 Motherboard Assembly are as follows:

J2 PIN	SIGNAL
1	LOCK\
2	TRK\
3	OUT5
4	OUT6
5	PD0
6	EXTFREQ
7	PD7
8	VDD (+5)
9	PD6
10	GND

GPS OPTION 40B**GPS OPTION MOTHERBOARD
ASSEMBLY 35007-2
W/3 BNC OUTPUTS****GPS OPTION 40BP****1.0 INTRODUCTION**

GPS Option 40B (Motherboard Assembly 35007-2) provides the expansion capability to add optional assemblies to the GPS Timing Unit. It provides a platform to support these assemblies and an interface between these assemblies and the GPS Main Assembly 35002.

The Motherboard Assembly can support two double width options or four single width options. Also, depending upon the options themselves and if space permits, some options can be stacked on top of other options.

The motherboard is also provided with a variety of rear panel butch plates and output connectors depending upon the option supplied.

GPS Option 40AP is identical to 40A except that 40AP includes the 812363-9 cable used to connect J2 of the 35007 Motherboard Assembly to J1 of the 55189 Power Entry and Alarm Relays Assembly. It provides the signal paths to and from the 55189 Assembly to the GPS Main Assembly 35002.

1.1 OPERATIONAL FEATURES

The basic motherboard has four plug-in option areas, J7/J9, J8/J10, J18/J22, and J19/J23. Each of these option areas provides one or two single-ended BNC outputs. However, depending upon the option installed, some of these outputs may or may not be used.

In this particular configuration, the output connector(s) for the optional assembly plugged into the J8/J10 and J7/J9 areas of the motherboard require excessive rear panel space. This requires removing motherboard BNCs J3A, J3B and J3C. The only remaining option areas with direct access to a rear panel BNC are J19/J23 and J18/J22.

Rear Panel Output Connector designations and signal characteristics are described in the GPS Option/Connector Configuration sheet located at the front of the ExacTime User's Guide.

APPENDIX C

The following is the correlation between the option area and the output:

AREA	REAR PANEL BNC	OPTIONAL BNC
J18/J22	J13E	J13D
J19/J23	J3F	

Each of the outputs is provided via a 250 milliamphere high speed buffer/driver. The gain of the buffer is 1:1 so the output amplitude is dependent on the input and the load.

For GPS Option 40BP, the signal connections provided at J2 of the 35007 Motherboard Assembly are as follows:

J2 PIN	SIGNAL
1	LOCK\
2	TRK\
3	OUT5
4	OUT6
5	PD0
6	EXTFREQ
7	PD7
8	VDD (+5)
9	PD6
10	GND

GPS OPTION 48

**PULSE RATE MODULE
ASSEMBLY 100001 and 100001-1**

1.0 INTRODUCTION

This option provides the capability of generating 3 (three) separate pulse rate outputs. Each of the outputs can be one of sixteen individually selected pulse rates.

This assembly is installed on the GPS Motherboard Assembly 35007 (typically GPS Option 40). Pulse Rate Module Assembly 100001 provides the three pulse rate outputs on SMB connectors that are usually connected via coax cables to rear panel BNC connectors in a 2U (3 ½ inch high) ExacTime chassis. Assembly 100001-1 is also installed on the GPS Motherboard Assembly. However, its pulse rate outputs are routed to the Motherboard Buffers/Drivers and appear on three of the six rear panel BNC connectors J3A through J3F.

For the assembly type and pulse rate output connector designations, refer to the GPS Option/Connector Configuration sheet in the ExacTime User’s Guide.

1.1 FUNCTIONAL EXPLANATION

The three separate pulse rates are generated by PGA (Programmable Gate Array) U1 which is programmed/configured by PROM (Programmable Read-Only Memory) U2 at initial power on. These pulse rates are buffered by Buffer/Driver U3 and output on SMB connectors J2, J3, and J4, or input directly to the Motherboard and output on its BNC connectors. Table 1 below shows the relationship of the 3 pulse rate outputs and their respective output connectors.

TABLE 1

PULSE RATE OUTPUT	ASSEMBLY 100001 OUTPUT CONNECTOR DESIGNATION	ASSEMBLY 100001-1 OUTPUT CONNECTOR DESIGNATION
Output 1	SMB J4 (See Note 1)	Motherboard BNC J3A or J3D (See Note 2)
Output 2	SMB J3 (See Note 1)	Motherboard BNC J3B or J3E (See Note 2)
Output 3	SMB J2 (See Note 1)	Motherboard BNC J3C or J3F (See Note 2)

Note 1: These outputs are cabled internally in the ExacTime and appear on rear panel BNC connectors. Refer to the GPS Option/Connector Configuration sheet in the ExacTime User’s Guide for connector designations and locations.

Note 2: The specific Motherboard BNC designation is dependant on which Motherboard option area the Pulse Rate Module is installed. Refer to the GPS Option/Connector Configuration sheet in the ExacTime User’s Guide for connector designations and locations.

APPENDIX C

The specific pulse rate of each of the three outputs is individually selected by a 5 position DIP switch.

Switch SW1 controls the pulse rate of Output 1.

Switch SW2 controls the pulse rate of Output 2.

Switch SW3 controls the pulse rate of Output 3.

Switch SW4 is not used in this configuration, however if installed, its switches need to be “Open”.

The pulse rate selection for each of the outputs is the same and is shown in Table 2 on the next page.

Switch position “Closed” means pushed down.

Switch position “Open” means pushed up.

TABLE 2

Pulse Rate Selection
(Typical of switches SW1, SW2 & SW3)

Switch Position					Output Pulse Rate
1	2	3	4	5	
Closed	Closed	Closed	Closed	Open	1PPS
Open	Closed	Closed	Closed	Open	5PPS
Closed	Open	Closed	Closed	Open	10PPS
Open	Open	Closed	Closed	Open	20PPS
Closed	Closed	Open	Closed	Open	30PPS
Open	Closed	Open	Closed	Open	40PPS
Closed	Open	Open	Closed	Open	50PPS
Open	Open	Open	Closed	Open	60PPS
Closed	Closed	Closed	Open	Open	80PPS
Open	Closed	Closed	Open	Open	90PPS
Closed	Open	Closed	Open	Open	100PPS
Open	Open	Closed	Open	Open	120PPS
Closed	Closed	Open	Open	Open	180PPS
Open	Closed	Open	Open	Open	200PPS
Closed	Open	Open	Open	Open	240PPS
Open	Open	Open	Open	Open	500PPS

1.2 OUTPUT SPECIFICATIONS

Form Factor: Square Wave (50/50% duty cycle).
On-Time Edge: Rising edge.
Characteristics: TTL levels into 50 ohms.

ASSEMBLY 100001

NEAR SIDE OF P.C. BOARD SHOWN.

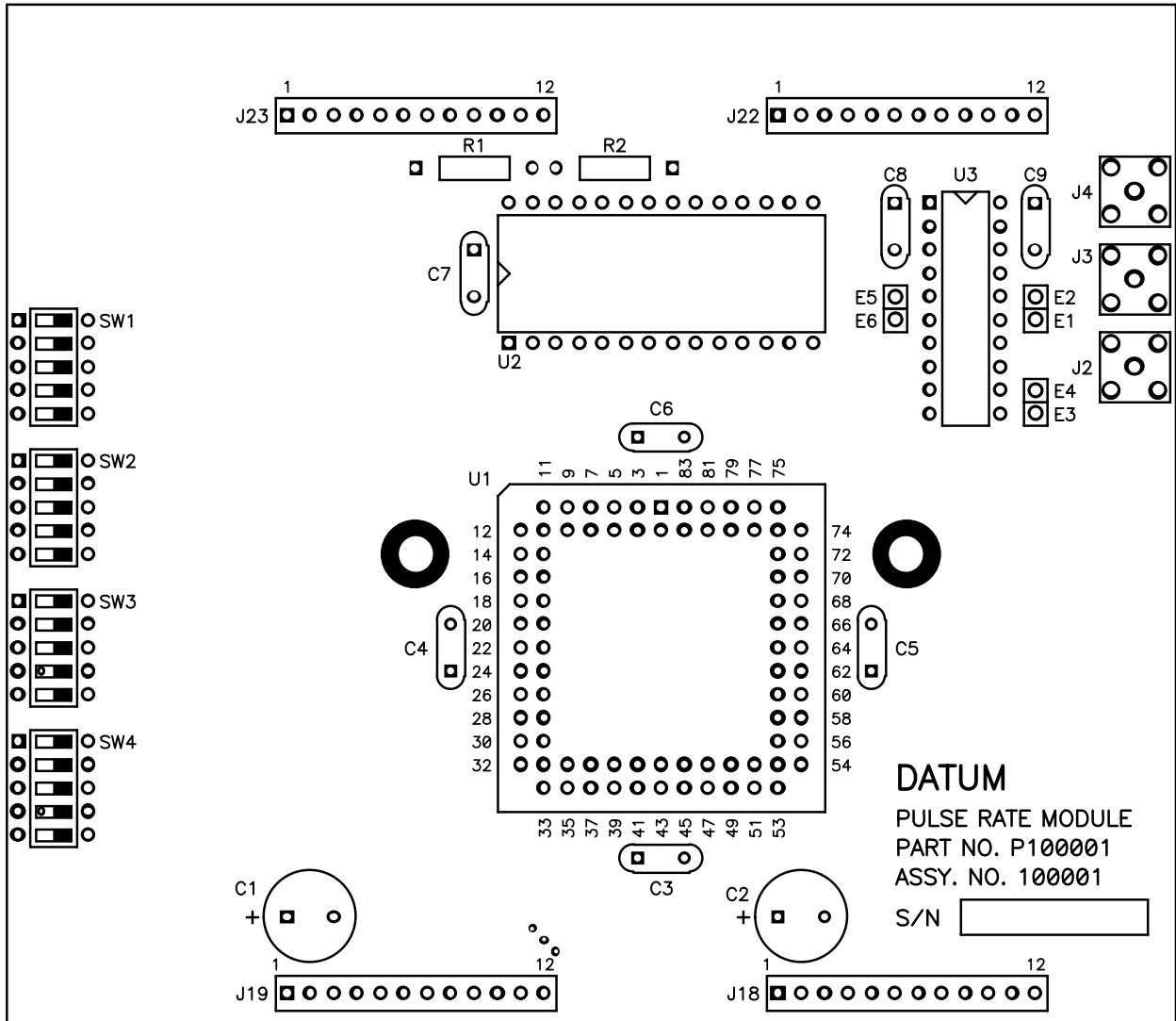

This Page Intentionally Left Blank

APPENDIX D

ANTENNA REPLACEMENT KIT

D.0 ANTENNA REPLACEMENT KIT

Please note that the GPS antenna equipment described in this manual has been superseded by the following Standard Antenna Kit, consisting of:

- One wide-range 5-12 VDC L1 antenna
- One 50 ft. length of Belden 9104 coaxial cable with BNC(m) and TNC(m) connectors
- Adaptors are included for GPS receivers that have a non-BNC antenna connector

The Antenna Kit can be ordered with optional cable lengths and accessories. Please note the following when setting up longer cable runs:

- Using Belden 9104, the maximum cable length without amplification is 150 feet
- Using Belden 9104, the maximum cable length using the optional in-line amplifier is 300 feet
- For cable runs longer than 300 feet, an optional GPS Down/Up Converter kit is available

Other GPS Antenna Options:

- A Lightning Arrestor kit
- A 1:2 splitter (distributes the signal from a single antenna to two GPS receivers)

This Page Intentionally Left Blank.



SYMMETRICOM TIMING & TEST
MEASUREMENT
3750 Westwind Blvd.
Santa Rosa, California 95403 USA
Tel: 707-528-1230
Fax: 707-527-6640
info@symmetricom.com
www.symmetricom.com

For more information about the complete range of Quality
Timing Products from the Symmetricom group of companies
call 1-800-544-0233 in the US and Canada.

Or visit our site on the world wide web at
<http://www.Symmetricom.com> for continuously updated
product specifications, news and information.